

Report

City of
Washington, IL
October 2019



Report for City of Washington, Illinois

Preliminary Engineering Study for the Farm Creek Trunk Sewer

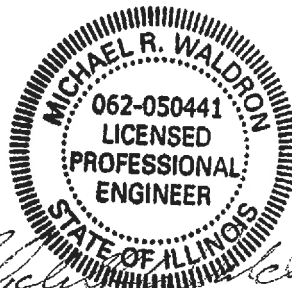

Michael R. Waldron 10/1/19
exp 11/30/19

Prepared by:

STRAND ASSOCIATES, INC.®
IDFPR No. 184-001273
1170 South Houbolt Road
Joliet, IL 60431
www.strand.com

October 2019



TABLE OF CONTENTS

Page No.
or Following

SECTION 1–BACKGROUND AND PURPOSE

1.01	Background.....	1-1
1.02	Purpose.....	1-1
1.03	Abbreviations	1-2

SECTION 2–EXISTING FARM CREEK TRUNK SEWER

2.01	Existing Sanitary Conveyance System	2-1
2.02	Flow Monitoring Results	2-1
2.03	Trunk Sewer Capacity Assessment.....	2-12

SECTION 3–FUTURE FARM CREEK TRUNK SEWER

3.01	Future Sanitary Conveyance System	3-1
3.02	Trunk Sewer Design Capacity	3-1
3.03	Trunk Sewer Route Alternatives	3-5
3.04	Trunk Sewer Modeling.....	3-10
3.05	Sewer Treatment Plant Modifications	3-11

SECTION 4–INFLUENT PUMPING AND EXCESS FLOW EVALUATION

4.01	Introduction	4-1
4.02	Influent Pumping Station	4-1
4.03	Excess Flow Evaluations.....	4-5

SECTION 5–OPINION OF PROBABLE CONSTRUCTION COST

5.01	Assumptions.....	5-1
5.02	Opinion of Probable Construction Cost (OPCC)	5-1

SECTION 6–RECOMMENDATIONS

6.01	Conclusions.....	6-1
6.02	Recommendations	6-2

TABLE OF CONTENTS Continued

Page No.
or Following

TABLES

2.02-1	Dry Weather Flow Metering Data	2-3
2.02-2	Selected Rainfall Events.....	2-6
2.02-3	Wet Weather Flow Metering Data.....	2-7
2.03-1	Theoretical Flow Calculations–Existing Conditions.....	2-13
2.03-2	Theoretical ADF Flow vs. Metered Dry Weather Flow	2-14
2.03-3	Theoretical Peak Flow vs. Metered Wet Weather Flows.....	2-15
2.03-4	Full Pipe Capacity vs. Theoretical Flows	2-16
2.03-5	Full Pipe Capacity vs. Metered Flow Conditions	2-18
3.02-1	Theoretical Flow Calculations–Future Conditions	3-2
3.02-2	Proposed Pipe Capacity for Future DPF Conditions	3-3
3.02-3	Proposed Pipe Capacity for Future DMF Conditions	3-4
4.01-1	Influent Flow Summary.....	4-1
4.03-1	Excess Flow Pump(s) Design Criteria	4-6
4.03-2	Excess Flow Channel Flow Capacity Calculations (Based on Manning’s Formula).....	4-8
4.03-3	Excess Flow Basin Retention Time (At Various Flows).....	4-9
4.03-4	Excess Flow Chlorine Contact Tanks (Existing).....	4-10
4.03-5	Effluent Limitations from Excess Flow Outfall A01 for Flows Greater than DMF (6.37 mgd)	4-11
4.03-6	Effluent Limitations from Excess Flow Outfall A01 and B01 for Flows Greater than DMF (6.37 mgd)	4-11
5.02-1	OPCC Alternate Route A.....	5-2
5.02-2	OPCC Alternate Route B.....	5-3
5.02-3	Submersible Pumping Station OPCC	5-4
5.02-4	Excess Flow Pumping Equipment OPCC	5-5

FIGURES

2.01-1	City of Washington Existing Sanitary Sewer System	2-1
2.01-2	Existing STP-1 Site Plan and Details.....	2-1
2.01-3	Existing STP-2 Site Plan and Details.....	2-1
2.02-1	Flow Meter Locations	2-2
2.02-2	Existing System Flow Schematic.....	2-2
2.02-3	Mass Balance at FM-6–Dry Weather Conditions	2-4
2.02-4	Mass Balance at FM-5–Dry Weather Conditions	2-4
2.02-5	Mass Balance at FM-2–Dry Weather Conditions	2-5
2.02-6	Metered Peaking Factors	2-8
2.02-7	Mass Balance at FM-6–July 6, 2016, Wet Weather Conditions	2-9
2.02-8	Mass Balance at FM-6–August 30, 2016, Wet Weather Conditions.....	2-9
2.02-9	Mass Balance at FM-5–July 6, 2016, Wet Weather Conditions	2-10
2.02-10	Mass Balance at FM-5–August 30, 2016, Wet Weather Conditions.....	2-10
2.02-11	Mass Balance at FM-2–July 6, 2016, Wet Weather Conditions	2-11
2.02-12	Mass Balance at FM-2–August 30, 2016, Wet Weather Conditions.....	2-11

TABLE OF CONTENTS Continued

		<u>Page No. or Following</u>
3.01-1	Future Contributing Areas	3-1
3.01-2	Future System Flow Schematic.....	3-1
4.02-1	Site Demolition Plan	4-2
4.02-2	Control Building Demolition Plans and Sections	4-2
4.02-3	Site Proposed Plan.....	4-2
4.02-4	Control Building Proposed Plans and Sections.....	4-2

APPENDICES

- APPENDIX A–ALTERNATE ROUTE A PLAN AND PROFILE DRAWINGS
- APPENDIX B–ALTERNATE ROUTE B PLAN AND PROFILE DRAWINGS
- APPENDIX C–TRUNK SEWER MODELING EXHIBITS

SECTION 1
BACKGROUND AND PURPOSE

1.01 BACKGROUND

The City of Washington, Illinois (City) owns and operates its own sanitary sewer conveyance system and wastewater treatment facilities. The City is served through a network of local and collector sewers, most of which are tributary to the Farm Creek trunk sewer (trunk sewer). The trunk sewer was constructed in the early 1970s with concrete bell and spigot piping. It flows east to west, generally parallel to Farm Creek, between Sewer Treatment Plant 1 (STP 1) and Sewer Treatment Plant 2 (STP 2).

The City continues to have operational problems with the trunk sewer, primarily because of its proximity to the creek. The creek is highly erodible and exhibits severe creek bank loss, depressional areas, and soils deposition. Review of historical aerial photography of the creek shows the creek centerline has continued to move over the past 20 years. cursory topographic survey data has also revealed the creek, in some locations, is a few feet deeper than the historical topographic mapping indicates. The instability of the creek has also exposed the trunk sewer in a number of locations. The sewer was originally constructed very shallow with invert depths less than 5 feet in many locations, and it appears several manhole rims are below the base flood elevation. The creek is also extremely serpentine with several manholes located on inside bends making them inaccessible to City staff.

The City has also reported excess flow conditions during wet weather and high creek flow conditions, which was confirmed through flow metering, discussed further in Section 2.02. Although not specifically observed, manhole overflows have also been reported along the trunk sewer. The proximity of the trunk sewer and manholes to the creek increases the potential for inflow. The age of the trunk sewer pipe and joints as well as anticipated high ground water conditions increases the potential for infiltration. This combination of factors makes the trunk sewer at risk for recurring backups and overflows.

In addition to the current operational issues with the trunk sewer, the City is also under pressure for future modifications and potential development. The City has been mandated by the Illinois Environmental Protection Agency (IEPA) to decommission existing STP 1 on the east end of the trunk sewer. STP 1 provides for an excess flow bypass to provide primary treatment and controlled return of flows back into the trunk sewer. This apparently mitigates high flow conditions in the trunk sewer and allows for some side storage. Removal of STP 1 will result in full conveyance burden on the trunk sewer. The City also anticipates that it will continue to grow and develop, which will place additional conveyance pressure on the already stressed trunk sewer.

All of these factors have contributed to a need for the City to evaluate the trunk sewer and determine alternatives for replacement of the trunk sewer to address current and future conditions.

1.02 PURPOSE

The purpose of this preliminary engineering study is to evaluate the existing trunk sewer, and identify alternatives for the City to address its current and future sanitary conveyance needs through the following actions:

1. Characterize the City's existing sanitary collection and conveyance system.

2. Perform flow monitoring to quantify dry weather and wet weather flow conditions from the collection system and in the trunk sewer.
3. Assess potential future development in the City that would be tributary to the trunk sewer.
4. Determine design flow capacity requirements for a new trunk sewer based on existing and projected future flow conditions.
5. Identify potential trunk sewer routes and improvements at STP 2 influent pumping station to meet the design flow requirements.
6. Develop a concept level opinion of probable construction cost (OPCC) for the identified alternatives.

1.03 ABBREVIATIONS

ADF	average daily flow
City	City of Washington, Illinois
cy	cubic yards
dia	diameter
DMF	design maximum flow
DPF	design peak flow
EA	each
FM	flow meters
FNF	Funding Nomination Form
ft	foot
gpd	gallons per day
gpm	gallons per minute
hr	hour
IEPA	Illinois Environmental Protection Agency
IFL	Intended Funding List
I/I	inflow and infiltration
in	inch
LF	linear feet
mgd	million gallons per day
min.	minute
OPCC	opinion of probable construction cost
PE	population equivalent
ROW	right-of-way
SCADA	supervisory control and data acquisition
SSES	sanitary sewer evaluation study
STP 1	Sewer Treatment Plant 1
STP 2	Sewer Treatment Plant 2
VFD	variable frequency drive
WPCLP	Water Pollution Control Loan
WWTP	wastewater treatment plant

SECTION 2
EXISTING FARM CREEK TRUNK SEWER

2.01 EXISTING SANITARY CONVEYANCE SYSTEM

Figure 2.01-1 shows the existing sanitary sewer system tributary to the trunk sewer. This tributary sewer system can generally be broken down into eight existing sewerage basins tributary to the trunk sewer.

Basins 6, 7, 8, and 9 are upstream of STP 1 and the start of the trunk sewer. Figure 2.01-2 shows a site plan of STP 1 where an existing 42-inch sanitary sewer (labeled 21-inch in the figure) carrying flow from Basins 6, 7, 8, and 9 enters Control Chamber No. 1, which is the start of the trunk sewer. The intent of Control Chamber No. 1 is to allow a base flow to continue into the 21-inch diameter trunk sewer downstream with excess flow overtopping a center weir and flowing into STP 1 for primary treatment. This is a bottleneck for the upstream conveyance system and a location of potential overflow.

Flows through STP 1 receive primary treatment but are returned to the trunk sewer and not discharged to the creek. This bypass into STP 1 provides a dampening of flows, but ultimately all flow is still conveyed into the trunk sewer.

From STP 1 the trunk sewer flows mostly parallel to Farm Creek increasing in size from 21-inch to 36-inch diameter as tributary collector sewers connect from Basins 5, 4, and 3. The trunk sewer is concrete bell and spigot pipe and is relatively shallow and in close proximity to the creek.

The trunk sewer eventually combines with flow from Basin 1 at junction manhole (MH)-200 on the STP 2 site as shown on Figure 2.01-3. Flow then goes through a sluice gate structure before entering the influent pumping station wet well. The intent of the sluice gate was for the City to be able to control flow into the influent pumping station based on the station's pumping capacity allowing for storage in the upstream trunk sewer. However, over time, the sluice gate has stuck in a half open position, limiting flow into the pumping station.

As shown on Figure 2.01-3, when initially constructed, the influent pumping station at STP 2 had pump on set at elevation 629.0. Today the pump on is set at elevation 630.42. This is about one foot below the incoming trunk sewer at invert elevation 631.35. The sluice gate upstream of the pumping station was originally set such that it would close when influent levels in the pumping station reached elevation 640.0. Review of the trunk sewer profile indicates that there are manholes with rim elevations of 641.0 and 641.9, only 750 feet upstream of the pumping station. It is conceivable that during excess flow conditions, closing of the sluice gate could have caused these manholes to overflow. Furthermore, the sluice gate stuck in the half-open position is a bottleneck for the trunk sewer and raises concern for potential overflows from the trunk sewer.

2.02 FLOW MONITORING RESULTS

A flow monitoring program was conducted to identify flow characteristics of the existing sanitary sewer system and trunk sewer. This was an important step in preliminary engineering for the new trunk sewer because it was necessary to determine the existing trunk sewer's ability to serve the City's current sanitary conveyance needs, which further supported projection of the City's future sanitary sewer conveyance needs and design of the new trunk sewer system.

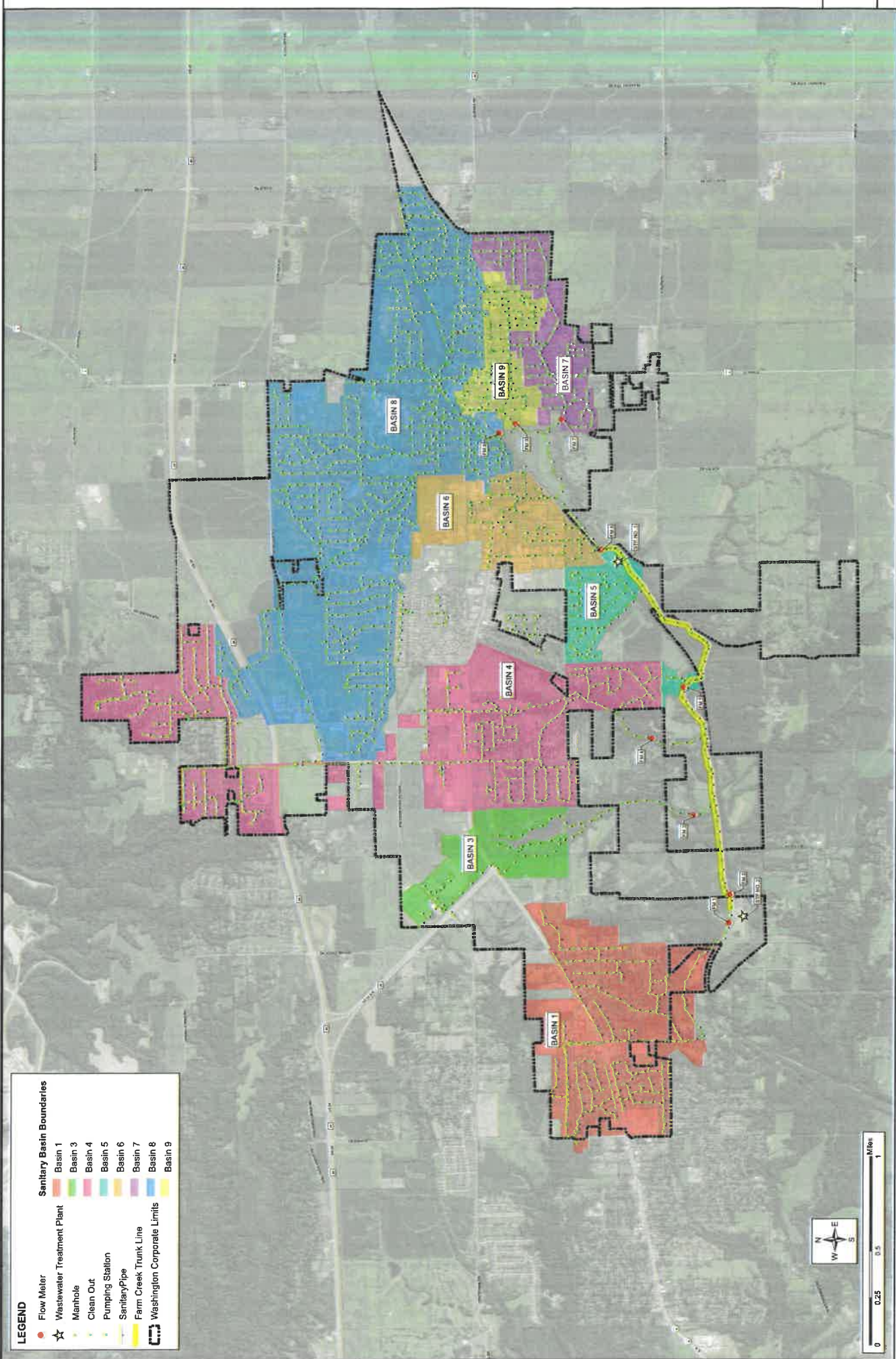

LEGEND

- Flow Meter
- ★ Wastewater Treatment Plant
- Manhole
- Clean Out
- Pumping Station
- Sanitary Pipe
- Farm Creek Trunk Line
- Washington Corporate Limits

Sanitary Basin Boundaries

- Basin 1
- Basin 2
- Basin 3
- Basin 4
- Basin 5
- Basin 6
- Basin 7
- Basin 8
- Basin 9



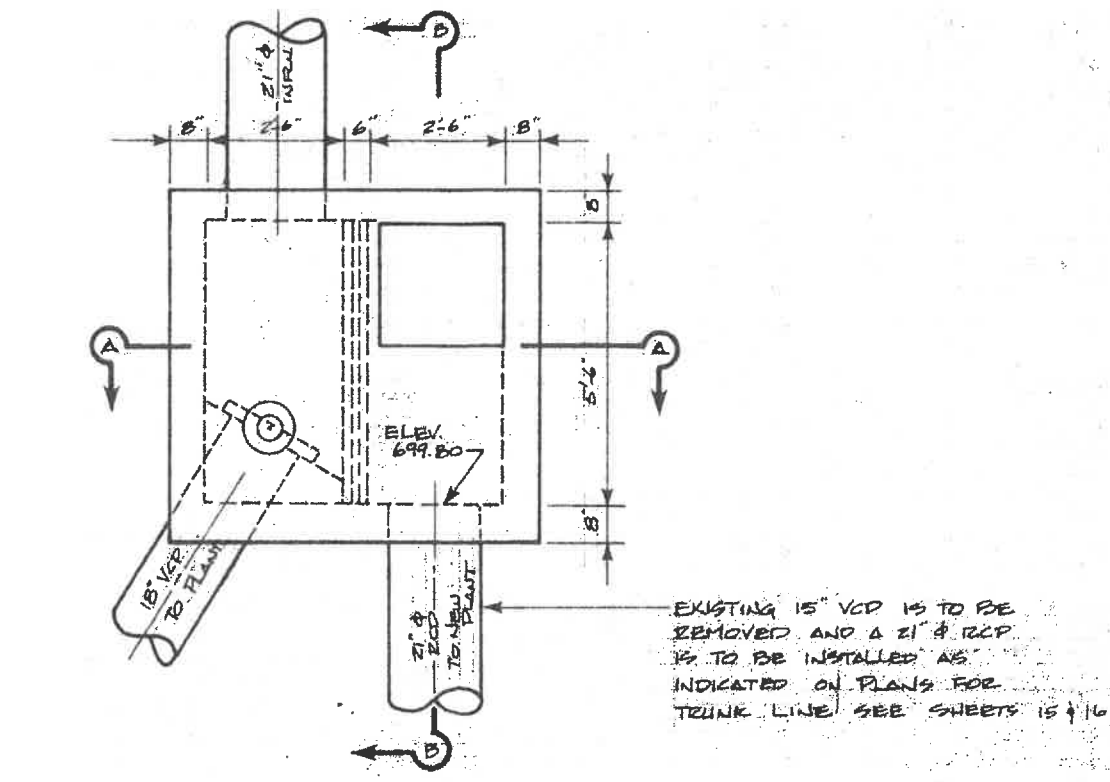

CONTROL CHAMBER NO. 1 PLAN VIEW
NOT TO SCALE

EXISTING 15" VCP IS TO BE REMOVED AND A 21" RCP IS TO BE INSTALLED AS INDICATED ON PLANS FOR TRUNK LINE. SEE SHEETS 15 & 16

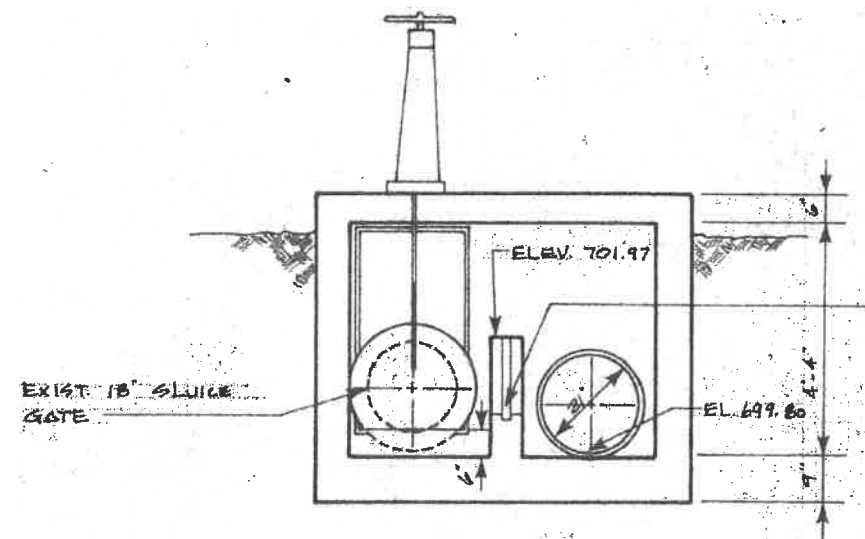

CONTROL CHAMBER NO. 1 A-A
NOT TO SCALE

EXIST CONCRETE WEIR IS TO BE REMOVED AND REBUILT AS INDICATED IN SECTION B-B & DETAIL C

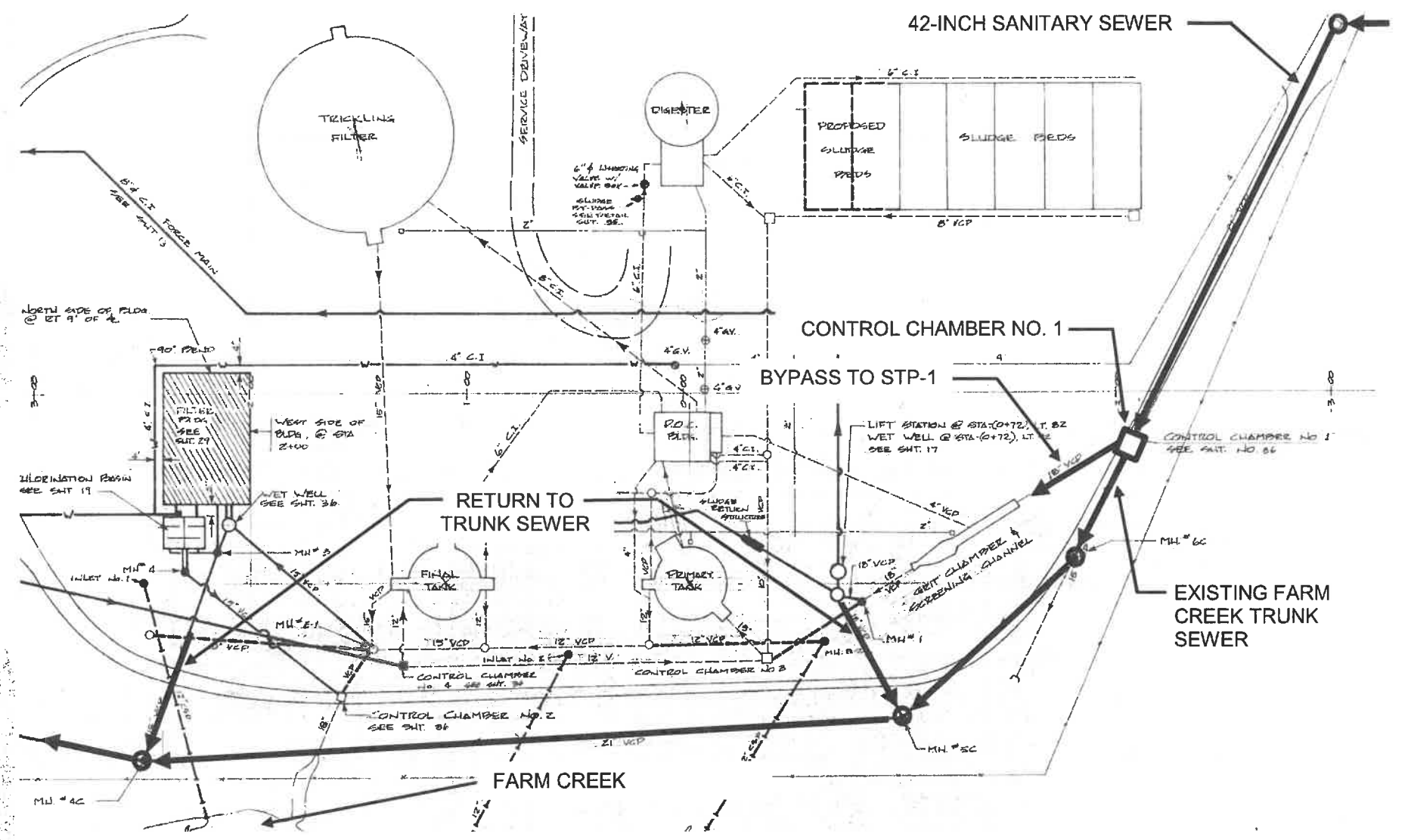

STP-1 SITE PLAN
NOT TO SCALE

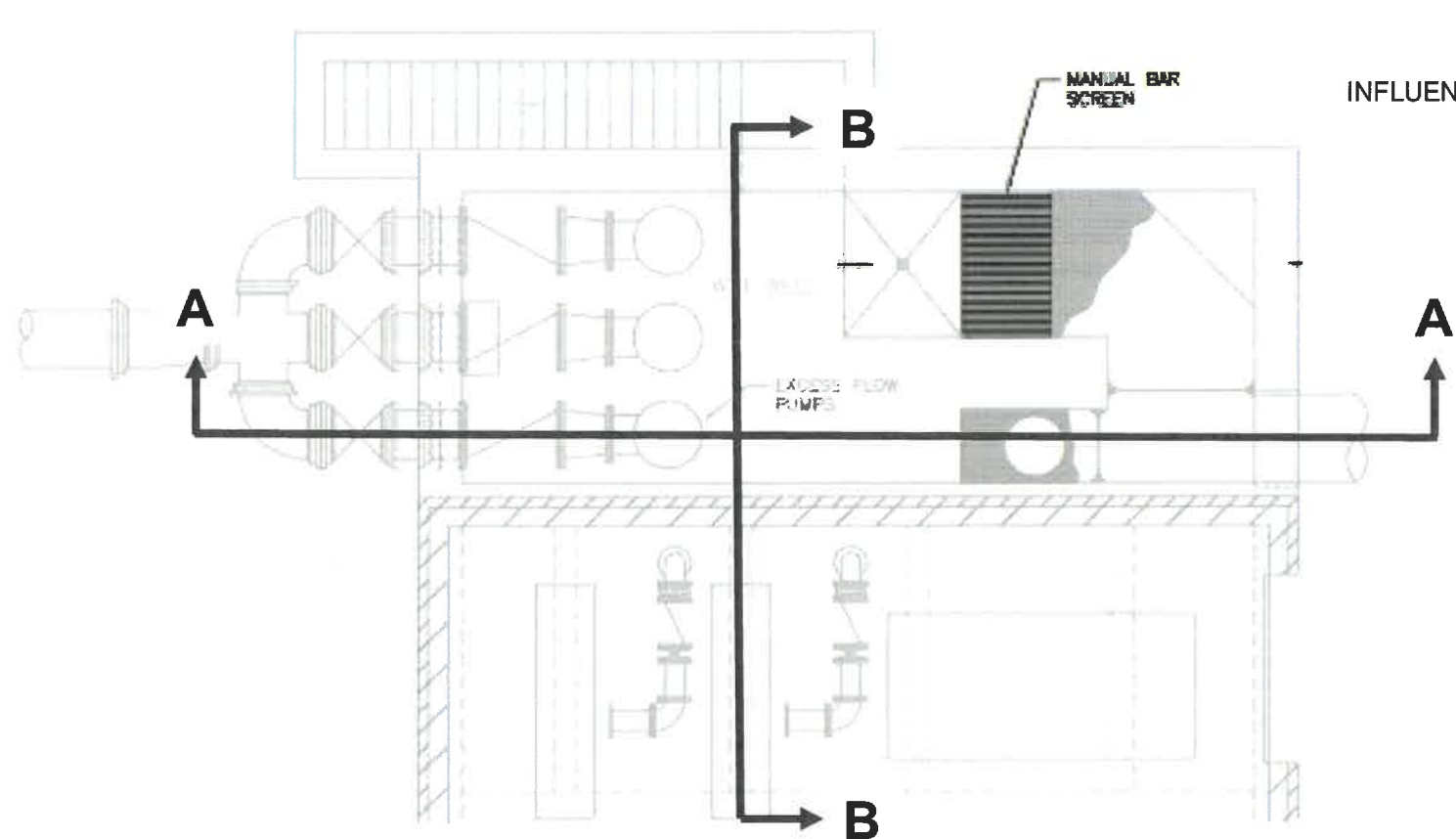

INFLUENT PUMPING STATION PLAN VIEW
NOT TO SCALE

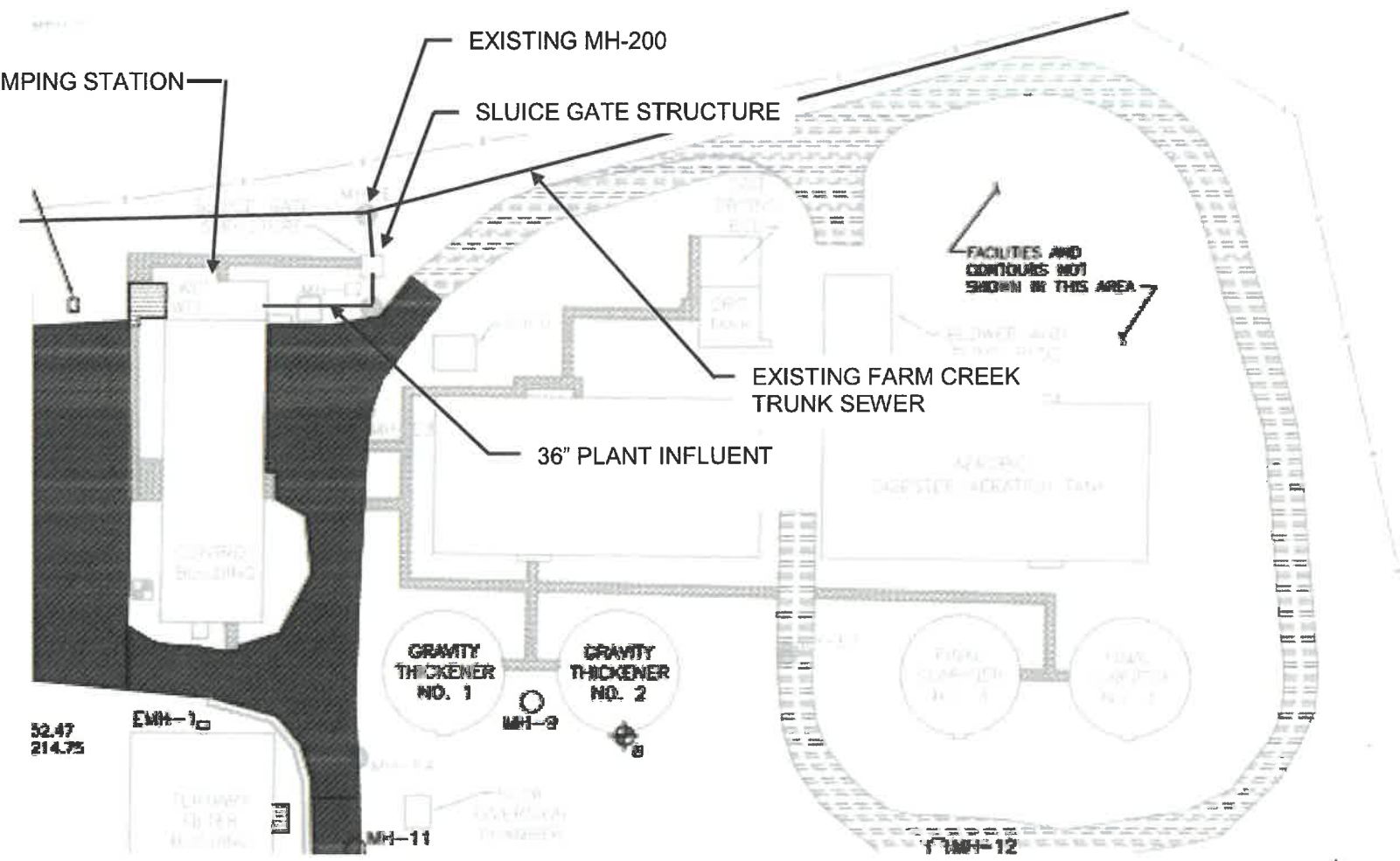

STP-2 SITE PLAN
NOT TO SCALE

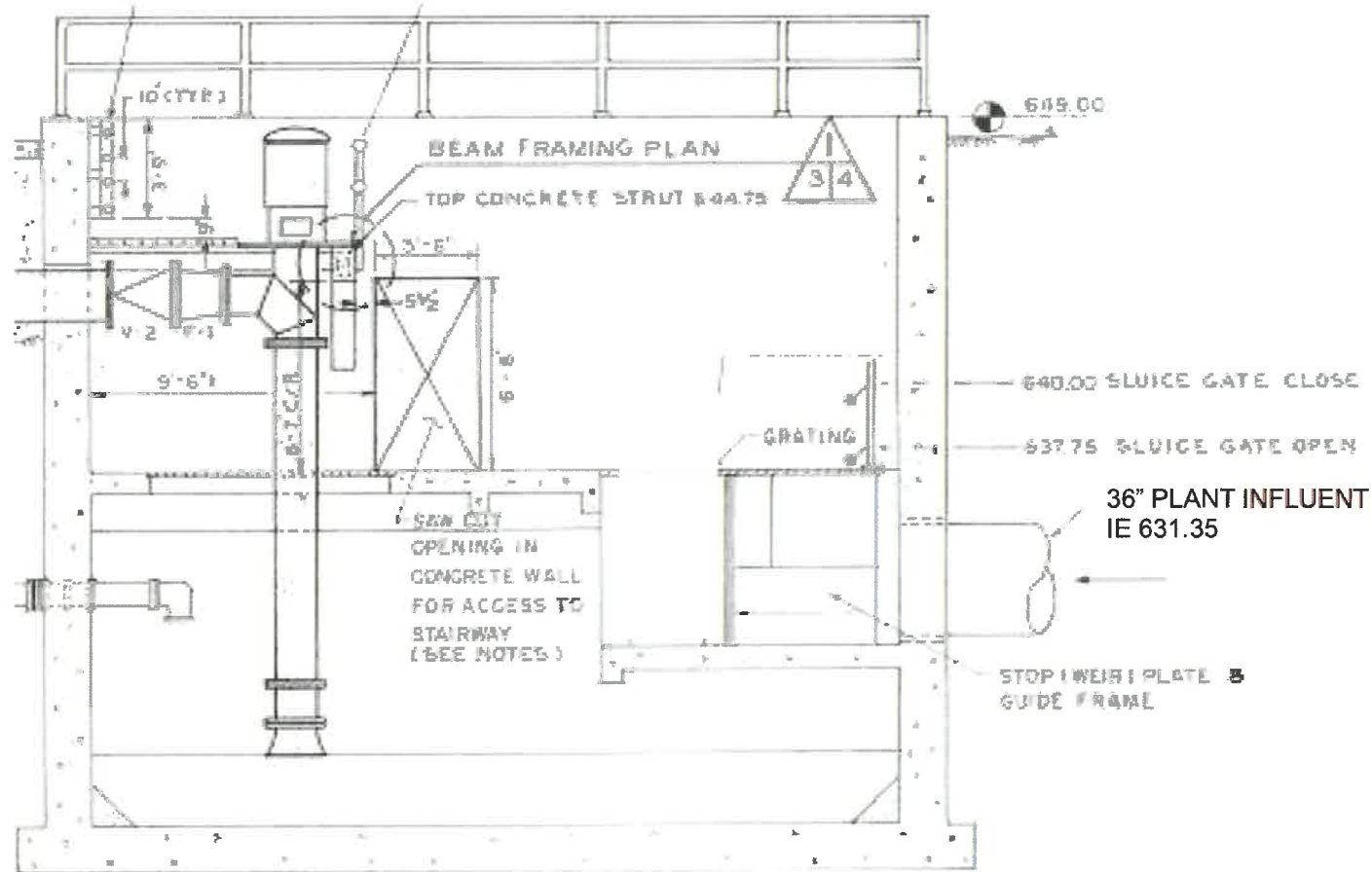

INFLUENT PUMPING STATION A-A
NOT TO SCALE

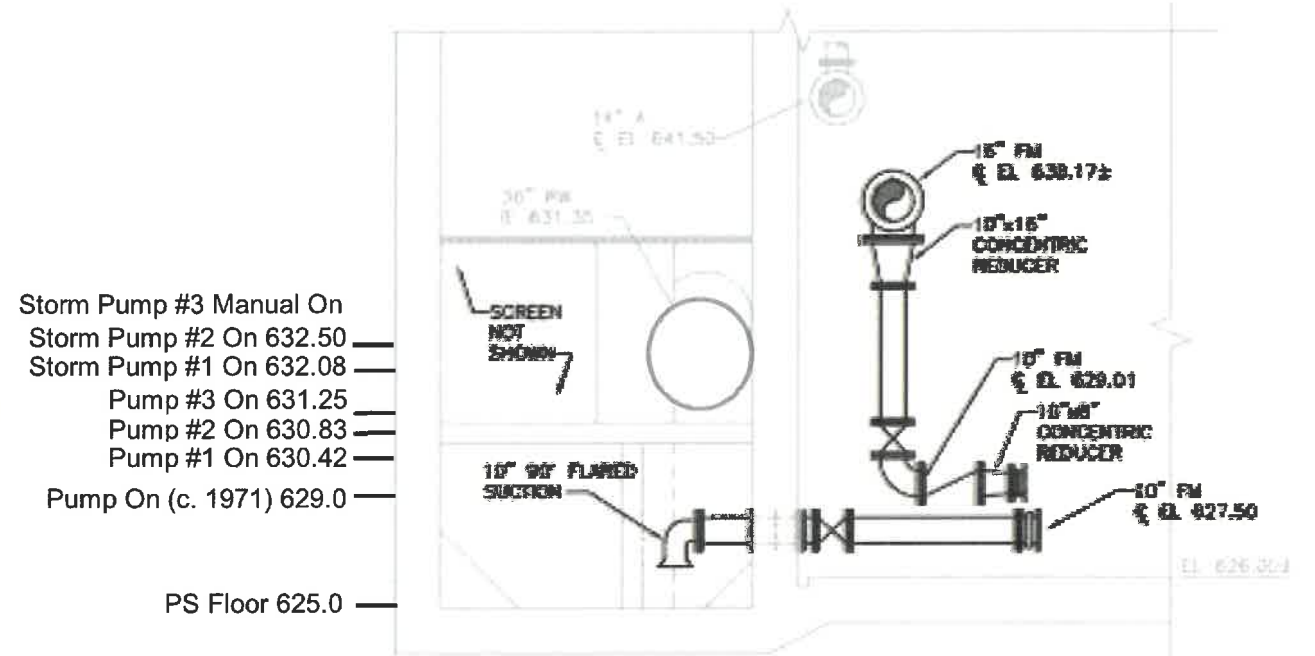

INFLUENT PUMPING STATION B-B
NOT TO SCALE

- Storm Pump #3 Manual On
- Storm Pump #2 On 632.50
- Storm Pump #1 On 632.08
- Pump #3 On 631.25
- Pump #2 On 630.83
- Pump #1 On 630.42
- Pump On (c. 1971) 629.0

Figure 2.01-3 Existing STP-2 Site Plan and Details

A. Flow Monitoring Program

From June 2, 2016, through September 14, 2016, flow monitoring was performed to quantify dry weather and wet weather flow conditions from the sanitary collection system and in the trunk sewer. Figure 2.02-1 shows the locations where eight flow meters (FM) were installed, effectively monitoring the eight sewerage basins shown in Figure 2.01-1. Figure 2.02-2 provides a flow schematic of the metering program.

FM-3 was only maintained until June 30, 2016. The tributary basin for this meter was very small and typically registered relatively small flows, which caused the meter to fail several times. It was determined that sufficient dry weather flow data was collected as well as one good wet weather event on June 22, 2016, so the meter was then removed and relocated to FM-9.

FM-1 and FM-2 had some problems during the flow monitoring period mainly because they were influenced by the sluice gate structure at STP 2. Scatter graph review of both meters indicated unstable flow conditions usually associated with flow impediments, which may have skewed the data. In particular, mass balance review of FM-2 often showed lower flows recorded at FM-2 than the sum of the FMs upstream (FM-3, FM-4, and FM-5). This would typically indicate a loss of flow upstream of FM-2, which might be expected during wet weather events if there were overflows from some of the low elevation manholes. But this condition was also seen during dry weather periods. One would also expect to see increased flow at FM-2 because of the trunk sewer's proximity to the creek and anticipated high groundwater effects. This mass balance issue is discussed further below.

FM-6 also had problems during the flow monitoring period because of influence from Control Chamber No. 1 at STP 1. This structure also caused back up flow conditions as exhibited through a scatter graph review. Similar to FM-2, mass balance evaluation of FM-6 also tended to show less flow at FM-6 than the sum of the upstream meters (FM-7, FM-8, and FM-9). Overflows have been reported from Control Chamber No. 1, which is downstream of FM-6, but it is also possible that overflows occurred upstream of FM-6.

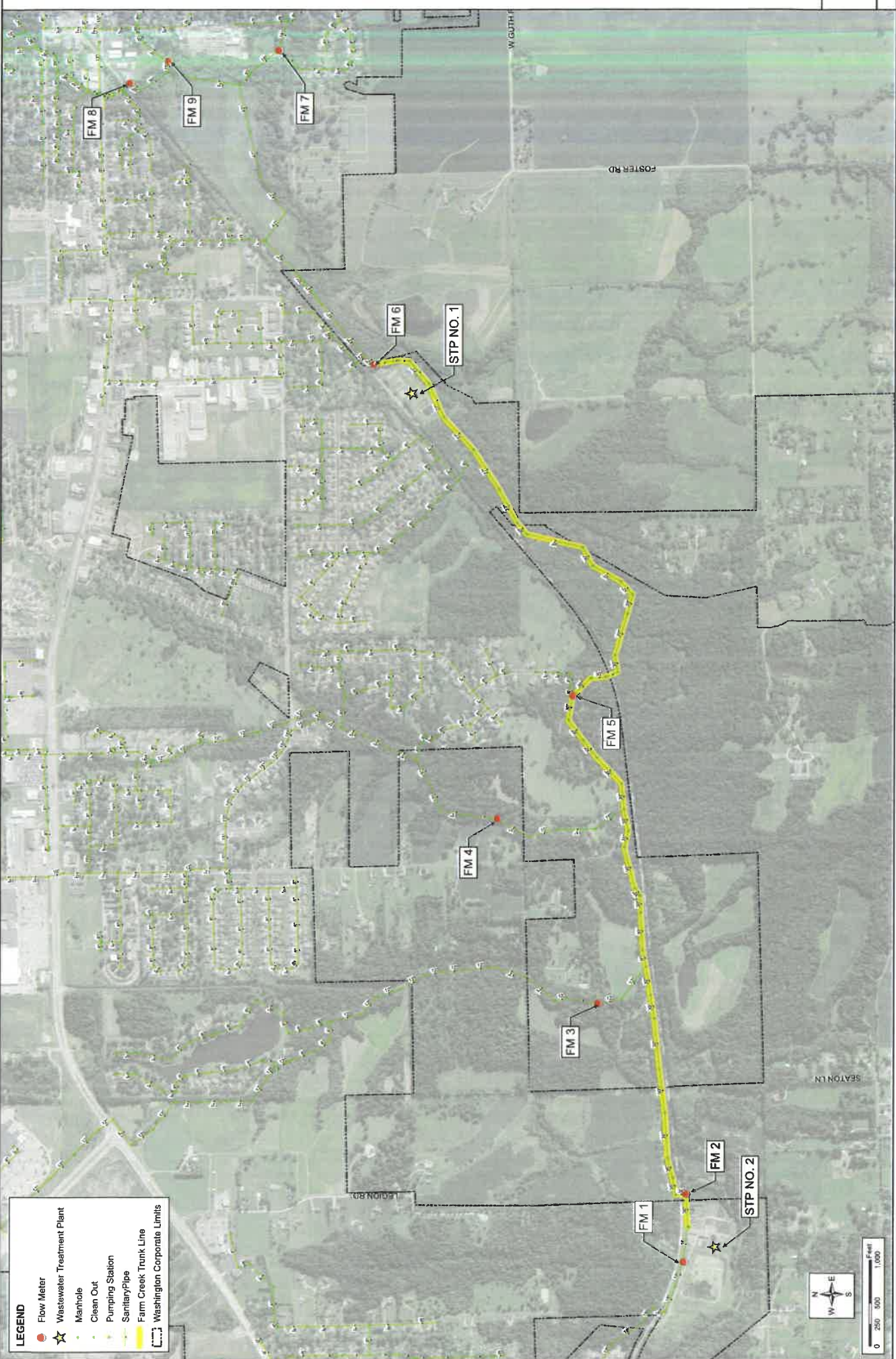

LEGEND

- Flow Meter
- ★ Wastewater Treatment Plant
- Manhole
- Clean Out
- Pumping Station
- Sanitary Pipe
- Farm Creek Trunk Line
- Washington Corporate Limits



Document Path: S:\CD\11659-195\11796260.dwg\GISMap\Figure 2.02-1_New Meter Locations_22_34.mxd

City of Washington

Farm Creek Trunk Sewer Flow Schematic - Existing Conditions

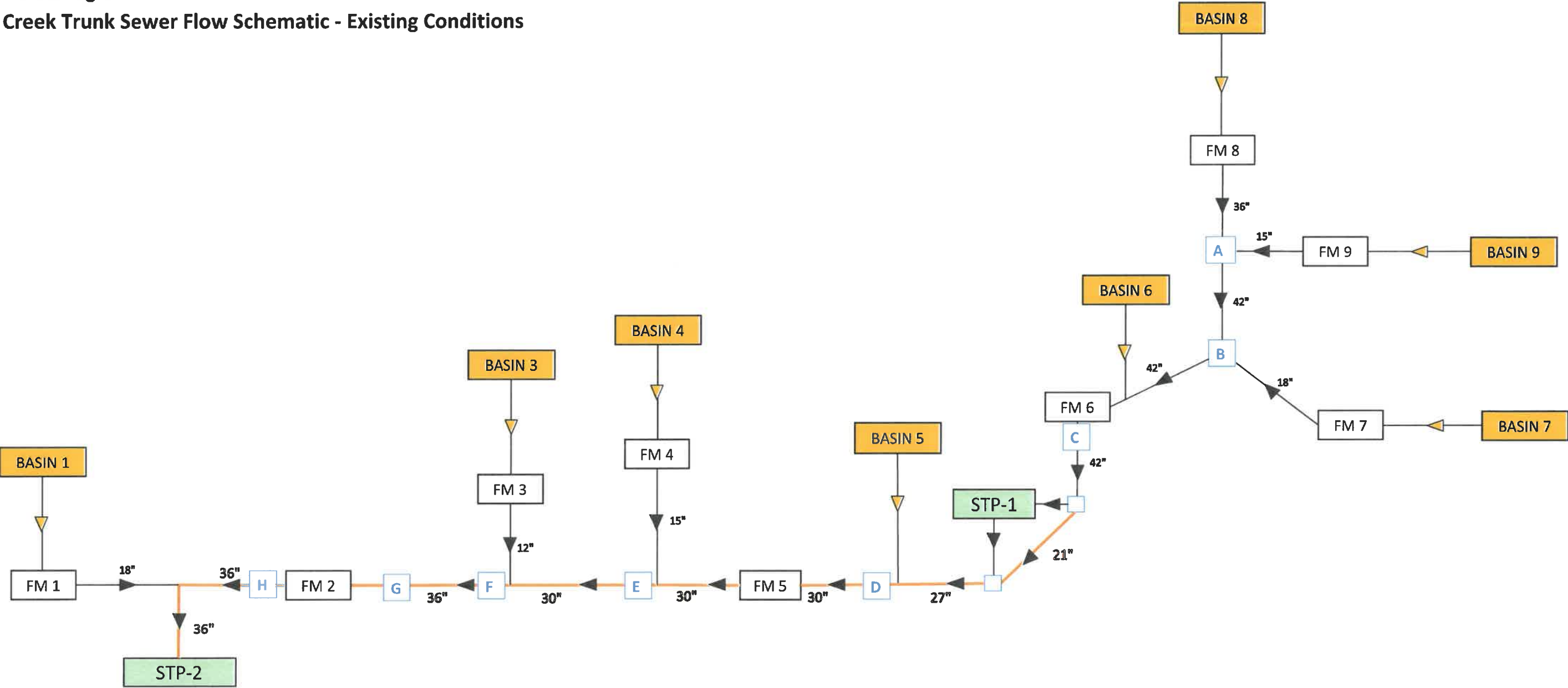

Figure 2.02-2 Existing System Flow Schematic

B. Dry Weather Conditions

A dry weather flow evaluation was performed for all nine FM over the flow monitoring period. Dry weather flow data was collected for all days in which less than 0.10 inch of rain fell in 24 hours preceded by at least two dry days. This data was used to determine base flow characteristics in the system as shown in Table 2.02-1.

Flow Meter	Dry Weather Flow [(gallons per minute (gpm))]		
	Minimum	Average	Maximum
FM 1	134	179	207
FM 2	623	1024	1631
FM 3	11	17	24
FM 4	195	349	499
FM 5	604	981	1513
FM 6	377	633	1062
FM 7	34	56	70
FM 8	395	636	1130
FM 9	61	78	92

Table 2.02-1 Dry Weather Flow Metering Data

Table 2.02-1 shows the lowest, highest, and average flow rates exhibited at the meter location over a 24-hour period for dry weather conditions. This information provides a base to which wet weather flow conditions were compared, as discussed below.

Mass balance evaluations were performed for FM-2, FM-5, and FM-6. These three meters were installed on the trunk sewer (FM-6 was actually immediately upstream of the start of the trunk sewer) and provided information on flow conditions in the trunk sewer. As shown in Figure 2.02-2, there are specific upstream meters feeding into these meters. For example, flows from FM-7, FM-8, and FM-9 join at Junction B and flow into FM-6. Basin 6 also contributes flow upstream of FM-6, so theoretically, subtracting FM-7, FM-8, and FM-9 flows from FM-6 flows should reveal flow contribution from Basin 6. However, that was not always the case. Most often this mass balance revealed less flow than the sum of the upstream meters. Figure 2.02-3 graphically shows this mass balance relationship for average dry weather conditions. Typically, this condition would indicate flow leaving the sewer system prior to FM-6, but this would not have been expected during dry weather flow conditions. So, it is not clear why this occurred except that FM-6 may have been influenced by the restriction at Control Chamber No. 1.

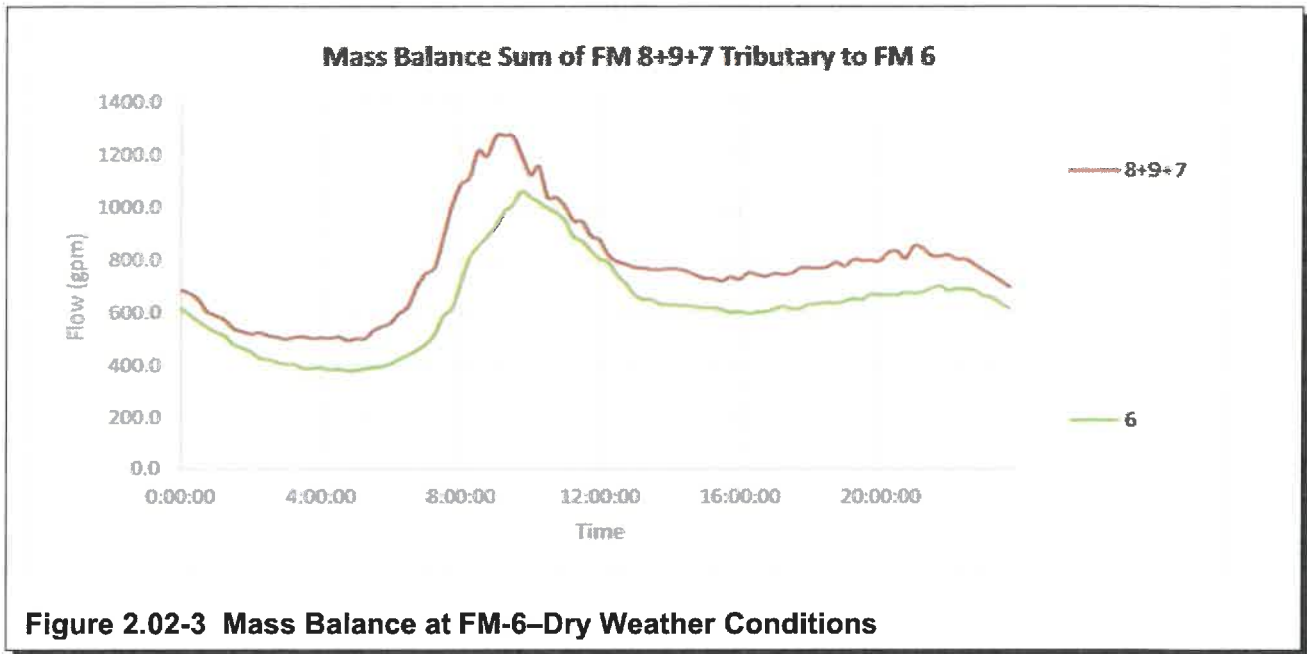

Figure 2.02-3 Mass Balance at FM-6–Dry Weather Conditions

The mass balance evaluation between FM-5 and FM-6 showed a significant increase in flow at FM-5, see Figure 2.02-4. An increase in flow was expected because Basin 5, a relatively small basin, contributes flow at two points along the segment of trunk sewer between FM-6 and FM-5. This segment is also in close proximity to the creek and is probably influenced by ground water infiltration even during dry weather conditions. However, the increase in flow measured was much greater than expected. As can be noted from Table 2.02-1, the average flow rate from FM-6 jumps by 55 percent through FM-5. This seems to indicate a significant excess flow contribution over this segment of trunk sewer.

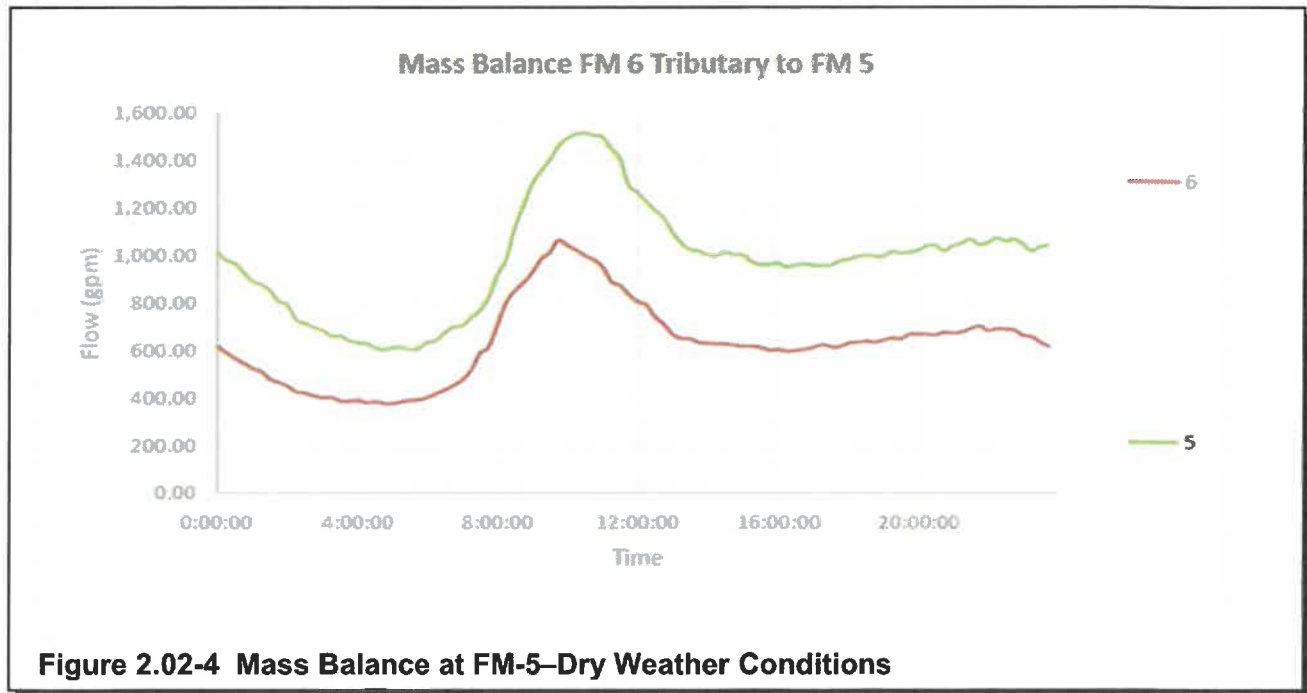

Figure 2.02-4 Mass Balance at FM-5–Dry Weather Conditions

Similar to FM-6, the mass balance evaluation for FM-2 often showed less flow at FM-2 than the sum of the upstream flows from FM-3, FM-4, and FM-5, see Figure 2.02-5. This would not have been expected during dry weather flow conditions, especially considering that the segment of trunk sewer being metered by FM-2 is so close to the creek and most likely influenced by groundwater infiltration. It is not clear exactly why this occurred except that FM-2 may have been influenced by the pumping conditions or the sluice gate restriction at STP 2.

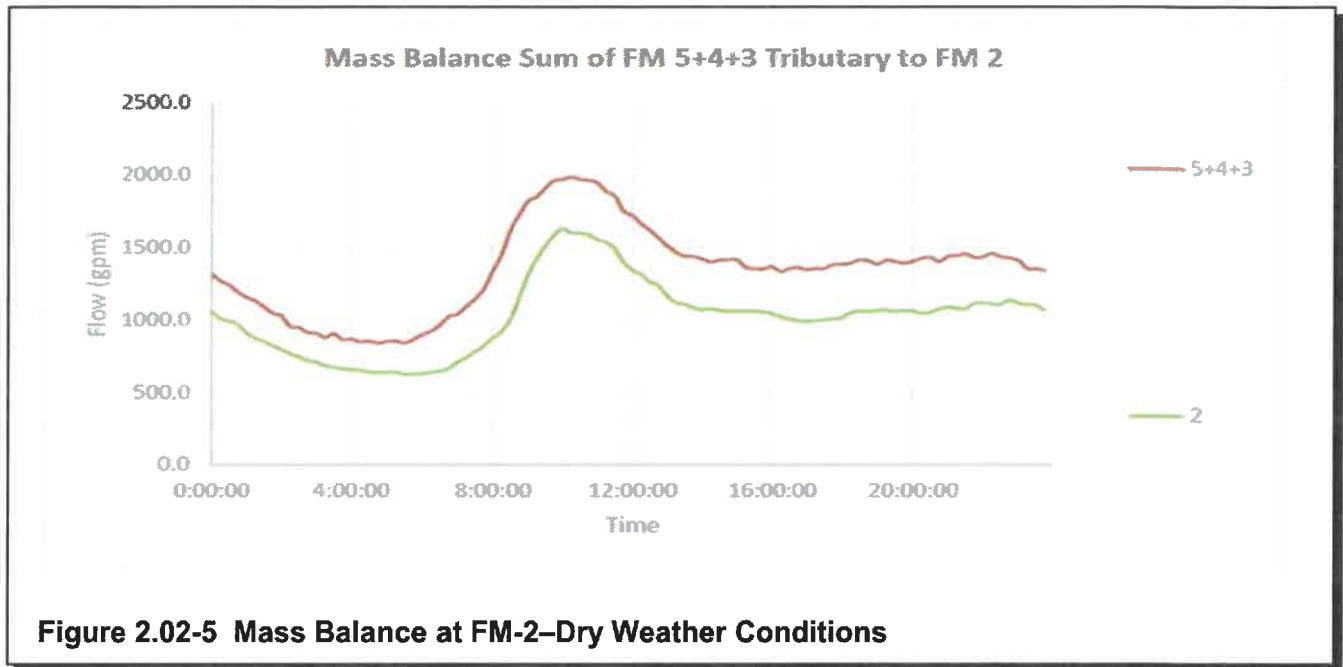

Figure 2.02-5 Mass Balance at FM-2—Dry Weather Conditions

C. Rainfall Analysis

Two rainfall gauges were installed, one at STP 1 and the other at STP 2. These gauges recorded 26 individual rainfall events over the flow monitoring period. Each event produced at least 0.10 inch of rainfall within a 24-hour period. Of these 26 rainfall events, three were identified for assessment of wet weather flow conditions in the sanitary sewer system, as shown in Table 2.02-2.

Date	Rain Gauge 1				Rain Gauge 2			
	Total Rainfall (in)	Total Duration (hr)	Maximum Rainfall Intensity	Maximum Rainfall Recurrence Interval	Total Rainfall (in)	Total Duration (hr)	Maximum Rainfall Intensity	Maximum Rainfall Recurrence Interval
July 6, 2016	1.77	4.50	0.75 in over 5 minutes (min.)	1.5 years	1.65	4.25	0.52 in over 15 min.	4.9 months
August 12, 2016	2.83	13.50	0.52 in over 15 min.	4.9 months	2.49	13.50	0.53 in over 15 min.	5.1 months
August 30, 2016	1.98	3.50	0.85 in over 15 min.	2.6 years	2.3	4.50	0.72 in over 15 min.	1.3 years

Table 2.02-2 Selected Rainfall Events

Qualification of these events for use in assessment of wet weather conditions was based on the following:

1. High intensity or quantity of rainfall
2. A range of durations so the system could be assessed for fast, high intensity impacts and for long, soaking impacts.
3. Uniformity of rainfall recorded at both rain gauges so that rainfall conditions in the eastern sewer basins would be similar to conditions in the western sewer basins.
4. Quality of flow data at each of the FMs before, during, and after the rainfall event.

As shown in Table 2.02-2, a recurrence interval was assigned to each rainfall event based on *Rainfall Frequency Atlas of the Midwest* by Huff and Angel for the most intense portion of the rainfall event.

D. Wet Weather Conditions

A wet weather flow evaluation was performed for all nine FMs for each of the selected rainfall events and is summarized in Table 2.02-3.

Table 2.02-3 Wet Weather Flow Metering Data

FM	Average Dry Flow (gpm)	Peak Wet Weather Flow (gpm)					
		July 6, 2016	Peaking Factor	August 12, 2016	Peaking Factor	August 30, 2016	Peaking Factor
FM 1	179	641	3.57	1,341	7.48	2,290	12.77
FM 2	1,024	5,759	5.62	10,571	10.32	12,114	11.83
FM 3 ¹	17	139	8.27	139	8.27	139	8.27
FM 4	349	639	1.83	795	2.28	909	2.60
FM 5	981	5,708	5.82	8,867	9.04	11,470	11.69
FM 6	633	4,719	7.45	7,133	11.27	11,671	18.44
FM 7	56	511	9.20	1,754	31.57	3,142	56.57
FM 8	636	3,610	5.67	3,557	5.59	9,584	15.06
FM 9	78	622	7.97	914	11.71	3,391	43.45

¹ Wet weather flow for FM-3 is from June 22, 2016

Table 2.02-3 shows the peak wet weather flow recorded at each FM for each of the three selected rainfall events. This peak flow was divided by the average dry weather flow for each FM to get a peaking factor for each FM. The peaking factor provides a magnitude of increase in flow over the average dry flow and is an indicator of the excess flow conditions in the sewer system because of wet weather conditions. This evaluation also provides an indicator of which sewer basin and which stretches of trunk sewer are most susceptible to inflow and infiltration (I/I) during wet weather conditions. The peaking factors are shown graphically in Figure 2.02-6.

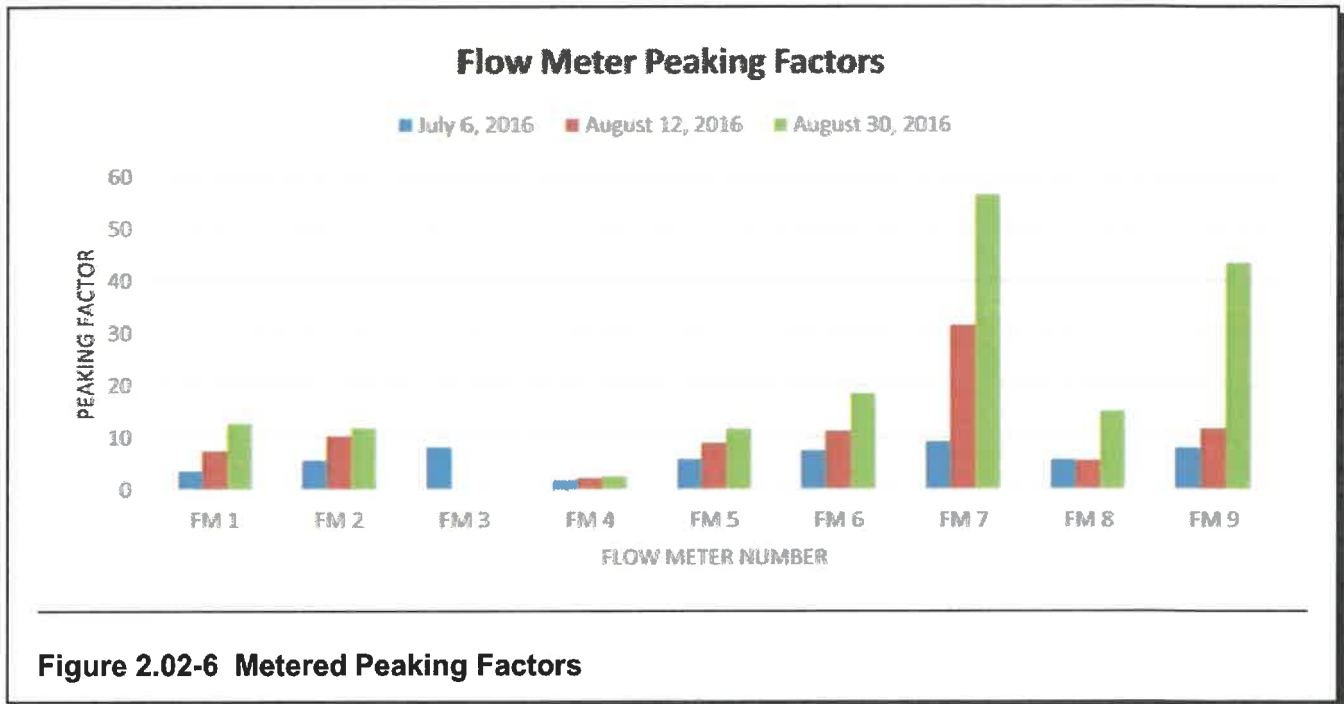

Figure 2.02-6 Metered Peaking Factors

Although statistically the July 6 and August 30 rainfall events are not very different, they had very different impacts on the sewer system. The August 30 event resulted in significantly greater flow increases in the sewer system. This could have been because of higher groundwater and creek level conditions prior to August 30 than July 6. In any case, the July 6 and August 30 events are considered to represent the low and high impact range of conditions in the sanitary sewer system because of wet weather conditions.

Similar to the dry weather analysis, mass balance evaluations were performed for FM-2, FM-5, and FM-6. Again, instability in the flow data was evident, but at all three FMs.

Figures 2.02-7 and 2.02-8 graphically show the mass balance at FM-6 for the July 6 and August 30 events, respectively. The July 6 event presented what would be expected for a mass balance with FM-6 indicating slightly more flow than the sum of the upstream meters, but the August 30 event showed FM-6 again registering lower flows. The August 30 event seems to have had a significant impact on excess flow conditions in the sewer system, so it is conceivable that there could have been system overflows upstream of FM-6.

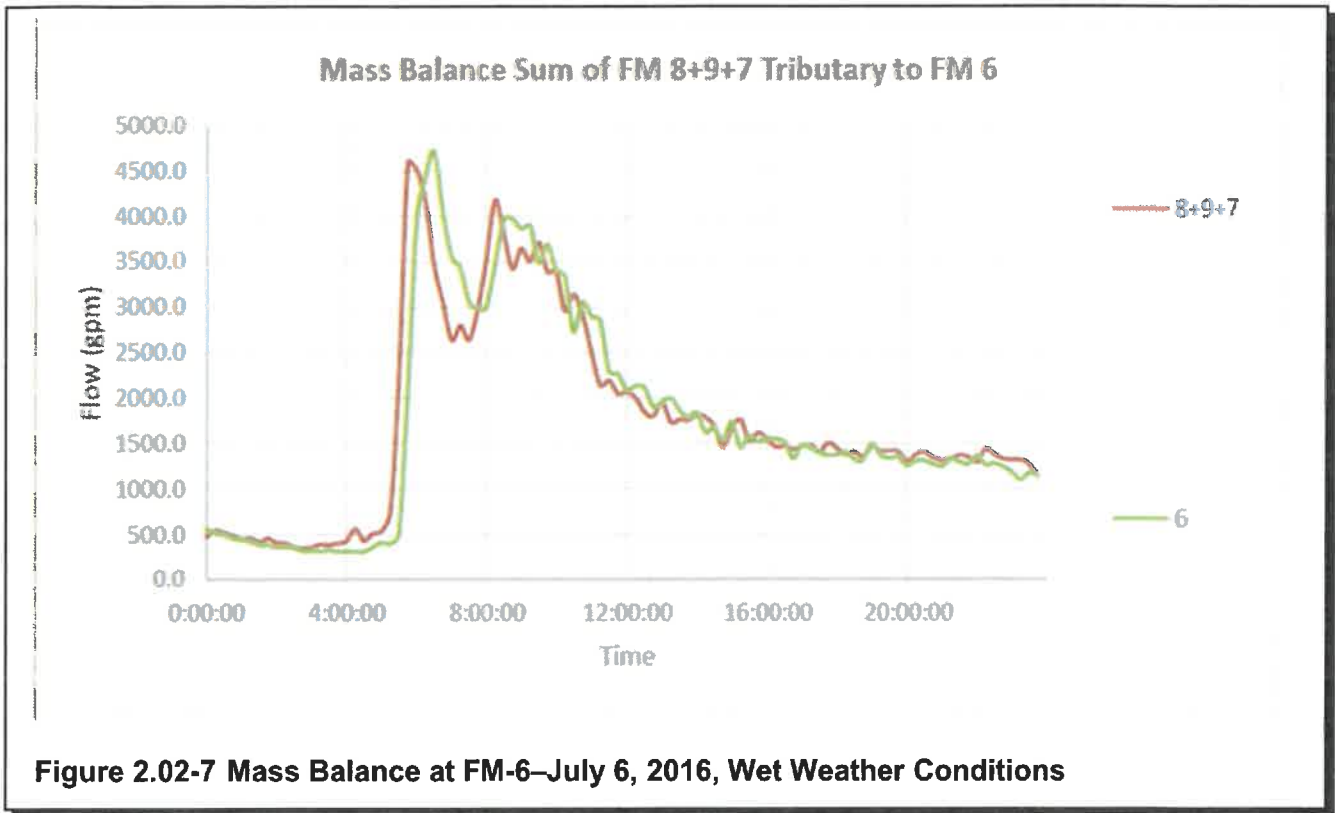

Figure 2.02-7 Mass Balance at FM-6—July 6, 2016, Wet Weather Conditions

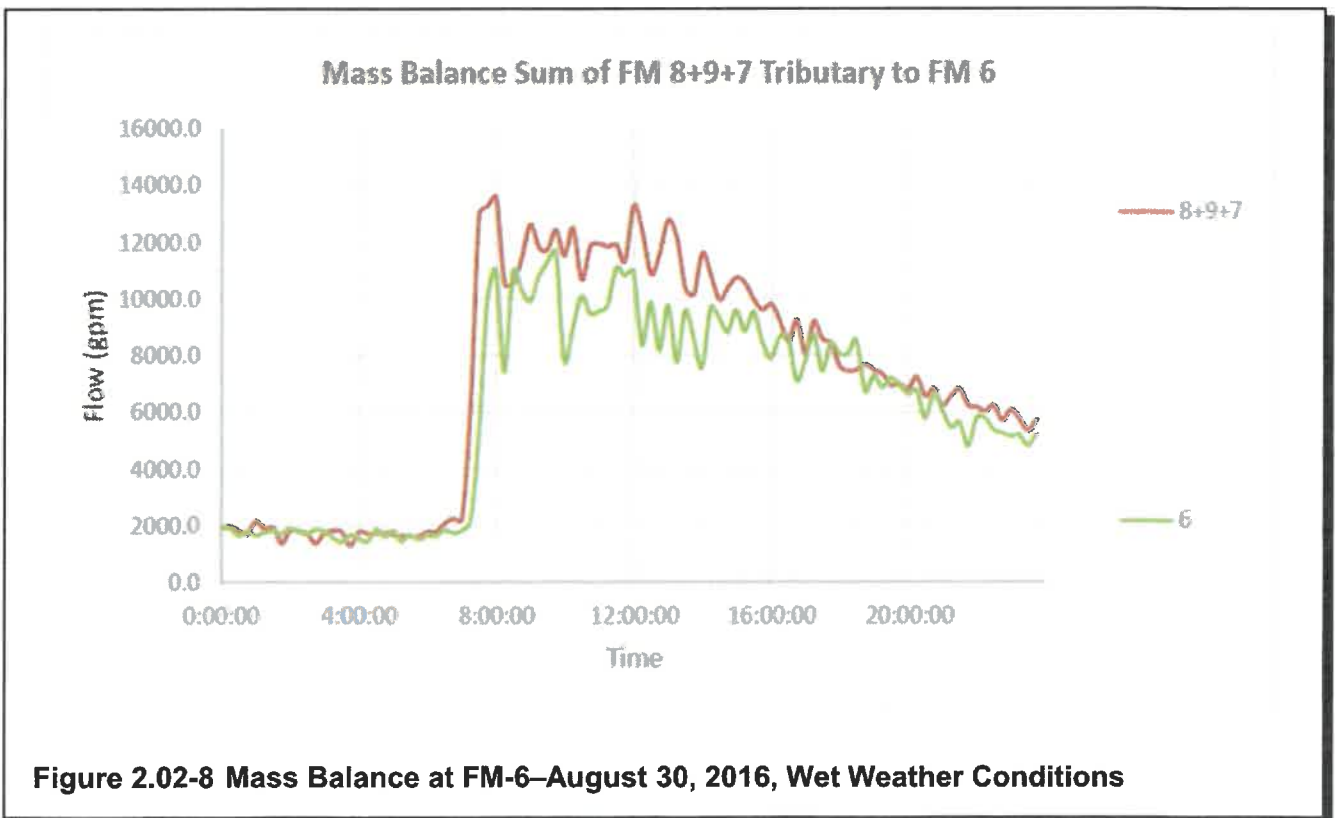

Figure 2.02-8 Mass Balance at FM-6—August 30, 2016, Wet Weather Conditions

Figures 2.02-9 and 2.02-10 graphically show the mass balance at FM-5 for the July 6 and August 30 events, respectively. FM-5 consistently showed greater flow than FM-6, which was expected. However, the August 30 event showed much closer conditions at FM-5 and FM-6, which may be indicative of overflows from the system between FM-6 and FM-5.

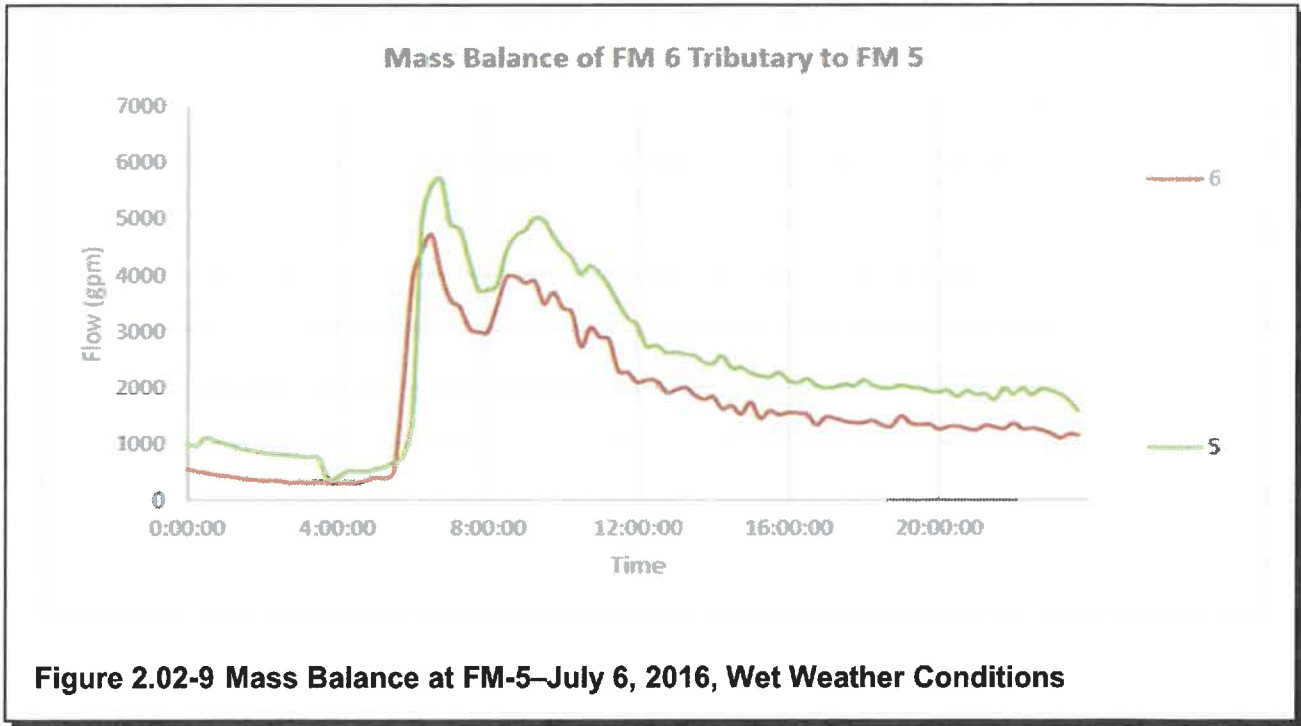

Figure 2.02-9 Mass Balance at FM-5—July 6, 2016, Wet Weather Conditions

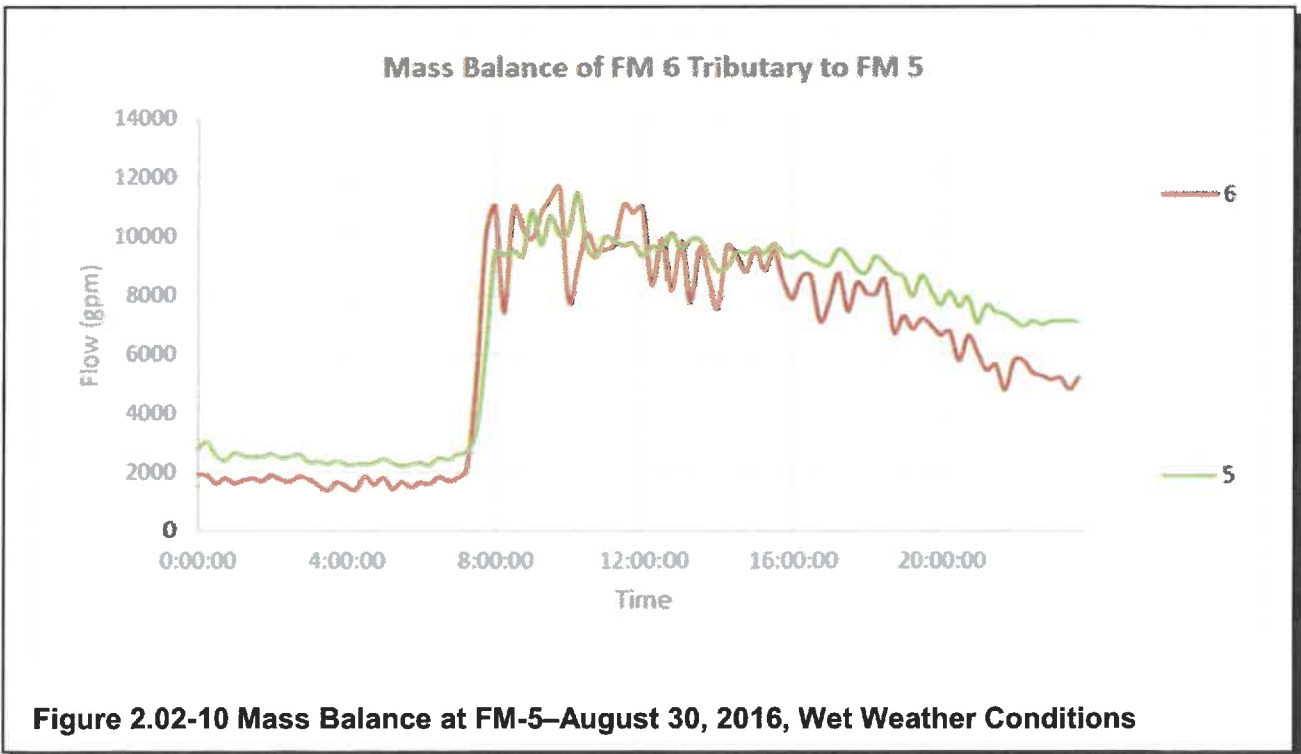

Figure 2.02-10 Mass Balance at FM-5—August 30, 2016, Wet Weather Conditions

Figures 2.02-11 and 2.02-12 graphically show the mass balance at FM-2 for the July 6 and August 30 events, respectively. In the case of FM-2, the mass balance results are much closer to what would have been expected, with FM-2 generally showing higher flows than the sum of the upstream FMs. FM-2 had experienced complications during the July 6 event. For unknown reasons, the meter stopped working in the middle of the study period, but the data retrieved up to that point provided valuable insight into the flow conditions at that meter location. Additionally, both events show characteristic jagged peaks and valleys indicative of influence from the downstream influent pumping station operation.

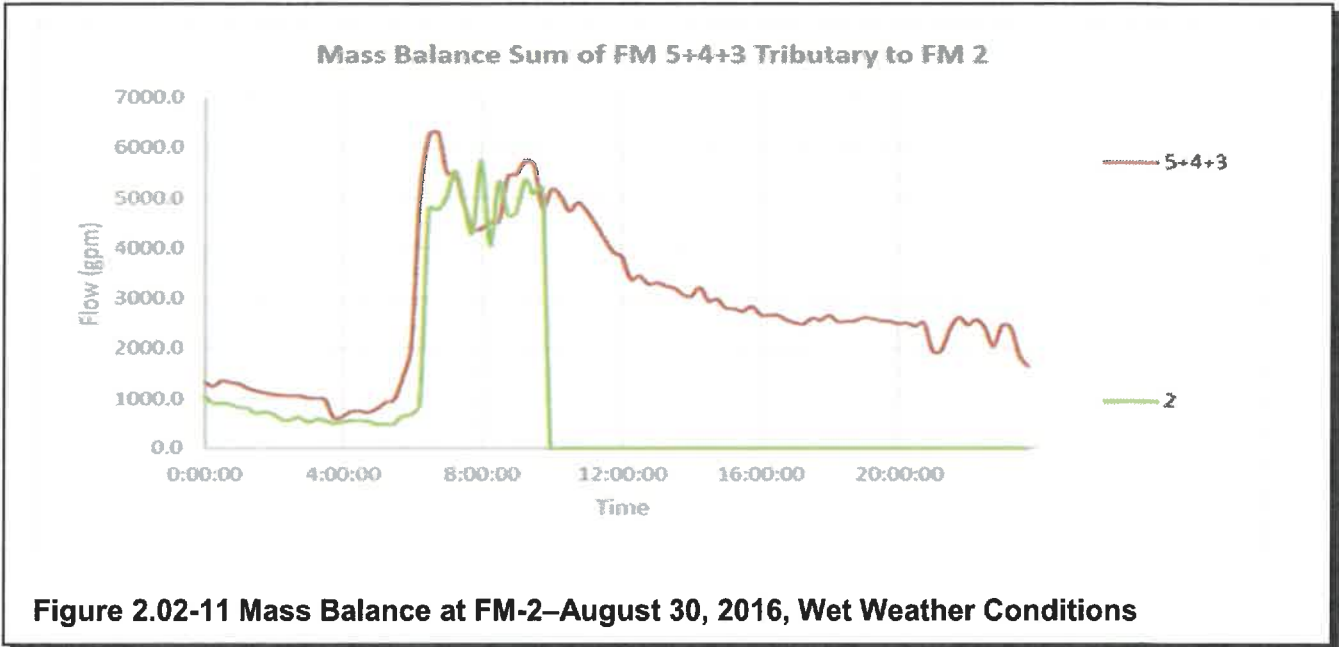

Figure 2.02-11 Mass Balance at FM-2—August 30, 2016, Wet Weather Conditions

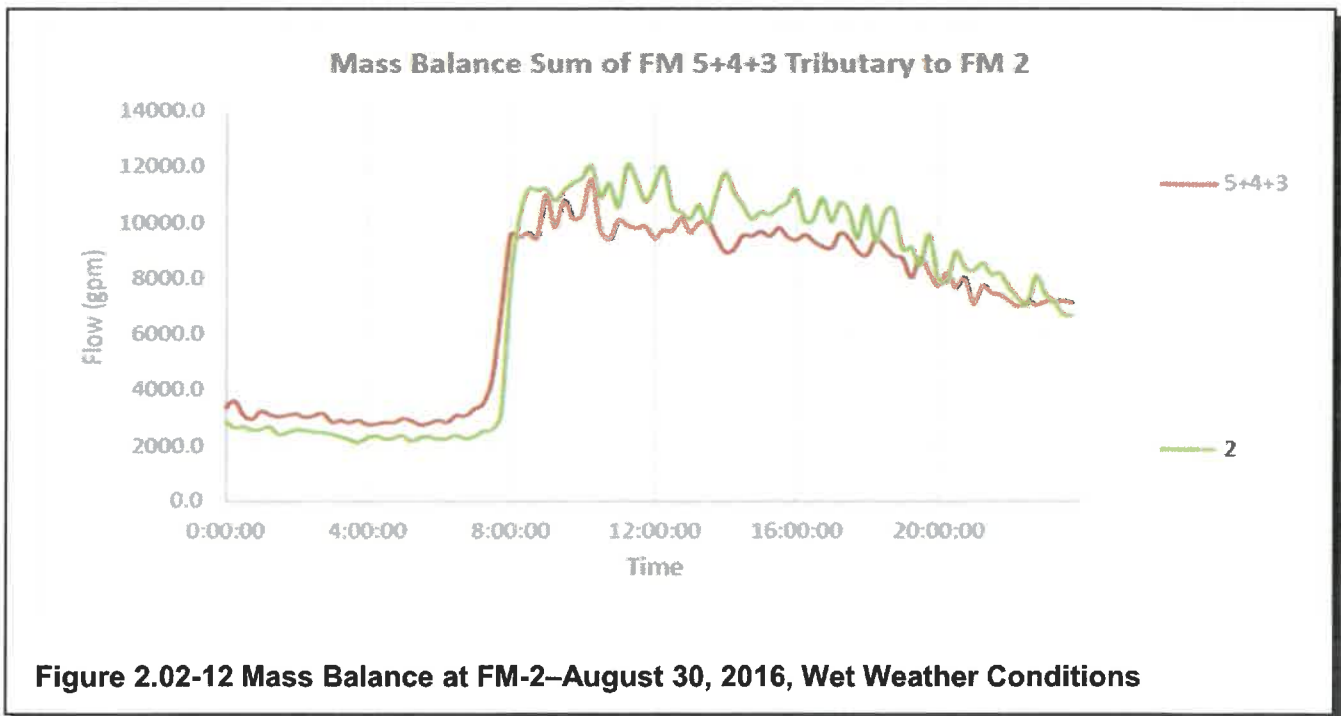

Figure 2.02-12 Mass Balance at FM-2—August 30, 2016, Wet Weather Conditions

A lot of attention was given to assessing these mass balances and the system characteristics being portrayed by the flow monitoring data because this data was used in the following sections to determine the existing trunk sewer's ability to serve the City's current needs and set the foundation of projecting the City's future flow conveyance needs.

2.03 TRUNK SEWER CAPACITY ASSESSMENT

A. Theoretical Flow Calculations—Existing Conditions

When the trunk sewer was originally constructed, it would have been designed to handle a theoretical flow based on the anticipated tributary service area. Over time, the characteristics of the anticipated tributary area continuously changes, so for this study, calculations of theoretical flow from the tributary service area as it exists today were performed and compared to the metered flow data to see how the tributary service area has changed.

Theoretical flows were calculated for existing development within each sewer basin shown in Figure 2.01-1. Theoretical flow was based on population equivalence (PE), or the number of "people" living (represented by homes) and working (represented by commercial, industrial, institutional, and businesses) within each basin as established by Illinois Municipal Code Title 35 Part 370, Recommended Standards for Sewer Works. One PE contributes 100 gallons per day (gpd) to the sanitary sewer system. Totalizing this flow results in the theoretical average daily flow (ADF) in the system.

From the total PE and the ADF, the theoretical peak flow in the system is calculated based on a peaking factor that is also established by Illinois Municipal Code Title 35 Part 370, Recommended Standards for Sewer Works.

Projecting the theoretical flow conditions onto the City's sanitary sewer system and trunk sewer is done based on the flow schematic shown in Figure 2.02-2. The results of the theoretical flow calculations are provided in Table 2.03-1 with the segments representing the trunk sewer shown in the grey shaded rows.

Flow Schematic	PE	ADF (gpm)	Peaking Factor	Peak Flow (gpm)
Basin 8	9,908	688	2.96	2,036
Basin 9	1,448	101	3.69	371
Junction A	11,356	789	2.90	2,287
Basin 7	1,446	100	3.69	371
Junction B	12,802	889	2.85	2,531
Basin 6	2,392	166	3.52	585
Junction C	15,194	1,055	2.77	2,925
Basin 5	728	51	3.88	196
Junction D	15,921	1,106	2.75	3,043
Basin 4	8,281	575	3.04	1,746
Junction E	24,202	1,681	2.57	4,319
Basin 3	1,109	77	3.77	290
Junction F	25,311	1,758	2.55	4,483
Junction G	25,311	1,758	2.55	4,483
Junction H	25,311	1,758	2.55	4,483
Basin 1	4,174	290	3.32	961
STP 2	29,485	2,048	2.48	5,087
STP 2 [million gallons per day (mgd)]		2.95		7.33

Note: Grey rows represent trunk sewer features.

Table 2.03-1 Theoretical Flow Calculations–Existing Conditions

The theoretical ADF calculations were compared to the average dry weather flow metering results as shown in Table 2.03-2.

Flow Schematic	Theoretical Average Daily (gpm)	Metered Average Dry (gpm)	Metered as a percent of Theoretical	Metered Maximum Dry (gpm)	Metered as a Percent of Theoretical
Basin 8 (FM-8)	688	636	92	1,125	164
Basin 9 (FM-9)	101	78	78	92	91
Junction A	789	714	91	1,217	154
Basin 7 (FM-7)	100	56	56	70	70
Junction B	889	770	87	1,287	145
Basin 6 ¹	166				
Junction C (FM-6)	1,055	633	60	1,062	101
Basin 5	51	345	683	558	1104
Junction D (FM-5)	1,106	981	89	1,513	137
Basin 4 (FM-4)	575	349	61	499	87
Junction E	1,681	1,330	79	2,012	120
Basin 3 (FM-3)	77	17	22	24	31
Junction F	1,758	1,347	77	2,036	116
Junction G	1,758	1,347	77	2,036	116
Junction H (FM-2)	1,758	1,024	58	1,631	93
Basin 1 (FM-1)	290	179	62	207	71
STP 2	2,048	1,203	59	1,838	90

Notes:

¹ FM 6 generally registered lower flows than FM-7, 8, and 9 combined resulting in negative dry weather flows from Basin 6. Grey rows represent trunk sewer features.

Table 2.03-2 Theoretical ADF Flow vs. Metered Dry Weather Flow

From Table 2.03-2 it can be seen that the metered dry weather flow generally was less than the theoretical ADF. The exception is for Basin 5 which showed significantly higher metered flow than would be anticipated from that basin. This further raises a concern about potential ground water and creek impacts on the trunk sewer. Table 2.03-2 also compared the maximum dry weather flow metered to the theoretical ADF. In this case, some of the basins had metered flow greater than the theoretical ADF.

This evaluation seems to indicate that the theoretical flow calculations generally reflect the current ADF conditions in the City falling between the average and peak metered flow. This provides confidence that the criteria used for calculating the theoretical flows can reliably be used for projecting future flows from future anticipated development.

The theoretical peak flow calculations were also compared to the wet weather flow metering results as shown in Table 2.03-3.

Flow Schematic	Theoretical Peak Flow (gpm)	July 6 Peak Flow (gpm)	Metered as a percent of Theoretical	August 30 Peak Flow (gpm)	Metered as a percent of Theoretical
Basin 8 (FM-8)	2,036	3,610	177	9,584	471
Basin 9 (FM-9)	371	622	168	3,391	914
Junction A	2,287	4,232	185	12,975	567
Basin 7 (FM-7)	371	511	138	3,142	848
Junction B	2,531	4,743	187	16,117	637
Basin 6 ¹	585	1,254	214	1,040	178
Junction C (FM-6)	2,925	4,719	161	11,671	399
Basin 5	196	1,668	850	2,583	1316
Junction D (FM-5)	3,043	5,708	188	11,470	377
Basin 4 (FM-4)	1,746	639	37	909	52
Junction E	4,319	6,347	147	12,379	287
Basin 3 (FM-3)	290	139	48	139	48
Junction F	4,483	6,486	145	12,518	279
Junction G	4,483	6,486	145	12,518	279
Junction H (FM-2)	4,483	5,759	128	12,114	270
Basin 1 (FM-1)	961	641	67	2,290	238
STP 2	5,087	6,400	126	14,404	283

Note: Grey rows represent trunk sewer features.

Table 2.03-3 Theoretical Peak Flow vs. Metered Wet Weather Flows

This evaluation showed that the July 6 wet weather event resulted in sewer system flows consistently greater than the theoretical peak flows and the August 30 event resulted in sewer system flow far greater than the theoretical peak flow. This evaluation coupled with the peaking factor evaluation discussed in Section 2.02.D. indicates that the City’s sanitary sewer system is experiencing excess flow conditions far beyond what the system may have been designed for.

B. Trunk Sewer Design Service Area Assessment

Building on the theoretical flow calculations, the theoretical ADF and peak flow calculations for existing conditions were used to determine whether development in the City has reached the design service area contribution intended for the trunk sewer by comparing full-pipe flow capacity of the sewer system and trunk sewer to the theoretical flow calculations. The results of this evaluation are shown in Table 2.03-4.

Table 2.03-4 Full Pipe Capacity vs. Theoretical Flows

Flow Schematic	Theoretical Average Daily (gpm)	Theoretical Peak Flow (gpm)	Existing Full-Pipe Capacity (gpm)			Percent of Pipe Capacity	
			Existing Pipe Size (inch)	Pipe Slope ⁵ (percent)	Existing Pipe Capacity	ADF (percent)	Peak Flow (percent)
Basin 8	688	2,036	36	0.046	6,420	11	32
Basin 9	101	371	15	0.150	1,123	9	33
Junction A	789	2,287	42	0.036	8,566	9	27
Basin 7	100	371	18	0.120	1,633	6	23
Junction B	889	2,531	42	0.036	8,566	10	30
Basin 6 ¹	166	585	18	0.120	1,633	10	36
Junction C ²	1,055	2,925	27	0.280	7,354	14	40
Basin 5	51	196	8	0.400	343	15	57
Junction D ³	1,106	3,043	30	0.058	4,433	25	69
Basin 4	575	1,746	15	0.150	1,123	51	155
Junction E	1,681	4,319	30	0.058	4,433	38	97
Basin 3	77	290	12	0.220	750	10	39
Junction F	1,758	4,483	36	0.046	6,420	27	70
Junction G	1,758	4,483	36	0.046	6,420	27	70
Junction H ⁴	1,758	4,483	36	0.046	6,420	27	70
Basin 1	290	961	18	0.120	1,633	18	59
STP 2	2,048	5,087	36	0.060	7,332	28	69
STP 2 (mgd)	2.95	7.33	0	0.000	11	28	69

¹ ADF comes from theoretical calculations

² Junction C uses sum of up stream flows and not FM-6

³ Junction D uses sum of up stream flows and not FM-5

⁴ Junction H uses sum of up stream flows and not FM-2

⁵ Pipe slope on existing interceptor from Austin Engineering, all other slopes are assumed minimum according to IEPA Title 35
Grey rows represent trunk sewer features.

From this evaluation it does not appear that the trunk sewer has reached its design service area contribution. Only the 30-inch-diameter segment between Junction E and Junction F is near design capacity at 97 percent. Basin 4 is served by a 15-inch-diameter sewer. It too appears to have reached its design capacity. Basin 4 appears have very little influence from wet weather events.

B. Trunk Sewer Capacity Assessment

For this study, it was determined that the average metered dry weather flow for each basin is appropriate to represent existing daily flows in the City. Based on planning discussions with City staff, it was determined that the July 6 wet weather event would be considered the design peak flow (DPF) for assessment of the trunk sewer system capacity. Furthermore, the August 30 wet weather event would be considered the design maximum flow (DMF) used to assess the trunk sewer system capacity to handle more extreme excess flow contributions.

Table 2.03-5 shows how the sanitary sewer system and trunk sewer full-pipe capacity compares to the ADF, DPF, and DMF.

Table 2.03-5 Full-Pipe Capacity vs. Metered Flow Conditions

Flow Schematic	Design Flows (gpm)		August 30, 2016 Maximum Flow (DMF)	Existing Full-Pipe Capacity (gpm)			Percent of Pipe Capacity		
	ADF	July 6, 2016 Peak Flow (DPF)		Existing Pipe Size (inch)	Pipe Slope ⁵ (percent)	Existing Pipe Capacity	ADF	DPF	DMF
Basin 8	636	3,610	9,584	36	0.046	6,420	10	56	149
Basin 9	78	622	3,391	15	0.150	1,123	7	55	302
Junction A	714	4,232	12,975	42	0.036	8,566	8	49	151
Basin 7	56	511	3,142	18	0.120	1,633	3	31	192
Junction B	770	4,743	16,117	42	0.036	8,566	9	55	188
Basin 6 ¹	166	585	585	18	0.120	1,633	10	36	36
Junction C ²	936	5,328	16,702	27	0.280	7,354	13	72	227
Basin 5	345	1,668	2,583	8	0.400	343	101	486	753
Junction D ³	1,281	6,996	19,285	30	0.058	4,433	29	158	435
Basin 4	349	639	909	15	0.150	1,123	31	57	81
Junction E	1,630	7,635	20,194	30	0.058	4,433	37	172	456
Basin 3	17	139	139	12	0.220	750	2	19	19
Junction F	1,647	7,774	20,333	36	0.046	6,420	26	121	317
Junction G	1,647	7,774	20,333	36	0.046	6,420	26	121	317
Junction H ⁴	1,647	7,774	20,333	36	0.046	6,420	26	121	317
Basin 1	179	641	2,290	18	0.120	1,633	11	39	140
STP 2	1,826	8,415	22,623	36	0.060	7,332	25	115	309
STP 2 (mgd)	2.63	12.12	32.58			10.56			

Notes:

- ¹ ADF comes from theoretical calculations
 - ² Junction C uses sum of up stream flows and not FM-6
 - ³ Junction D uses sum of up stream flows and not FM-5
 - ⁴ Junction H uses sum of up stream flows and not FM-2
 - ⁵ Pipe slope on existing interceptor from Austin Engineering, all other slopes are assumed minimum per IEPA Title 35.
- Grey rows represent trunk sewer features.

The results of this evaluation indicate that the existing trunk sewer from Junction C to Junction D was at 72 percent of its full-pipe capacity during the July 6 (DPF) event, but 227 percent during the August 30 (DMF) event. From Junction D (probably from the point of Basin 5 contribution) downstream to STP 2 the trunk sewer full-pipe capacity is exceeded for both the DPF and DMF conditions, in some cases by 3 or 4 times the pipe capacity.

This evaluation indicates that the current flow conditions in the City during wet weather conditions far exceed the trunk sewer full-pipe flow capacity and have the potential to result in significant system backups and overflows.

SECTION 3
FUTURE FARM CREEK TRUNK SEWER

3.01 FUTURE SANITARY CONVEYANCE SYSTEM

Figure 3.01-1 shows the projected additional future development areas that are anticipated to represent full buildout conditions for the City.

This projection fills in all vacant parcels within the City's current corporate limits and uses the City's zoning map to determine anticipated land uses for these parcels. Any parcels currently in unincorporated areas but surrounded by incorporated areas were added and assigned a land use based on the City's comprehensive plan. For parcels outside of the current corporate limits but within the 1.5-mile planning radius of the City, the City's comprehensive plan was used to determine future land uses, except on the west side of the City, which extended only to the planning boundary with neighboring City of East Peoria.

Under these future conditions there are also two new tributary areas to the trunk sewer; Basin 2 and Basin 10.

Figure 3.01-2 shows a flow schematic of the future conditions sanitary sewer and trunk sewer system.

3.02 TRUNK SEWER DESIGN CAPACITY

A. Theoretical Flow Calculations—Future Conditions

Similar to the process used in determining theoretical flows for the existing trunk sewer, theoretical flows were also calculated for the additional future development within each sewer basin shown in Figure 3.01-1. Theoretical flow was based on PE projected for the land uses dictated by the City's comprehensive plan and criteria under Illinois Municipal Code Title 35 Part 370, Recommended Standards for Sewer Works. As noted in Section 2.03, these criteria provide a reliable representation of flow contributions in the City.

To determine the future flow conditions, the theoretical flow calculations for the additional future development were added to the current metered flow conditions determined in Section 2. The future flow conditions were projected onto the City's sanitary sewer system and trunk sewer based on the flow schematic shown in Figure 3.01-2. The results of the theoretical flow calculations and determination of future flow conditions is provided in Table 3.02-1 with the segments representing the trunk sewer shown in the grey shaded rows.

LEGEND

- Flow Meter
- Wastewater Treatment Plant
- Manhole
- Clean Out
- Pumping Station
- Sanitary Pipe
- Farm Creek Trunk Line
- East Peoria/Washington
- Boundary Agreement
- Washington Corporate Limits
- Current Sanitary Basin
- Boundaries

Future Contributing Areas

- Basin 1
- Basin 2 (NEW)
- Basin 3
- Basin 4
- Basin 5
- Basin 6
- Basin 7
- Basin 8
- Basin 10 (NEW)

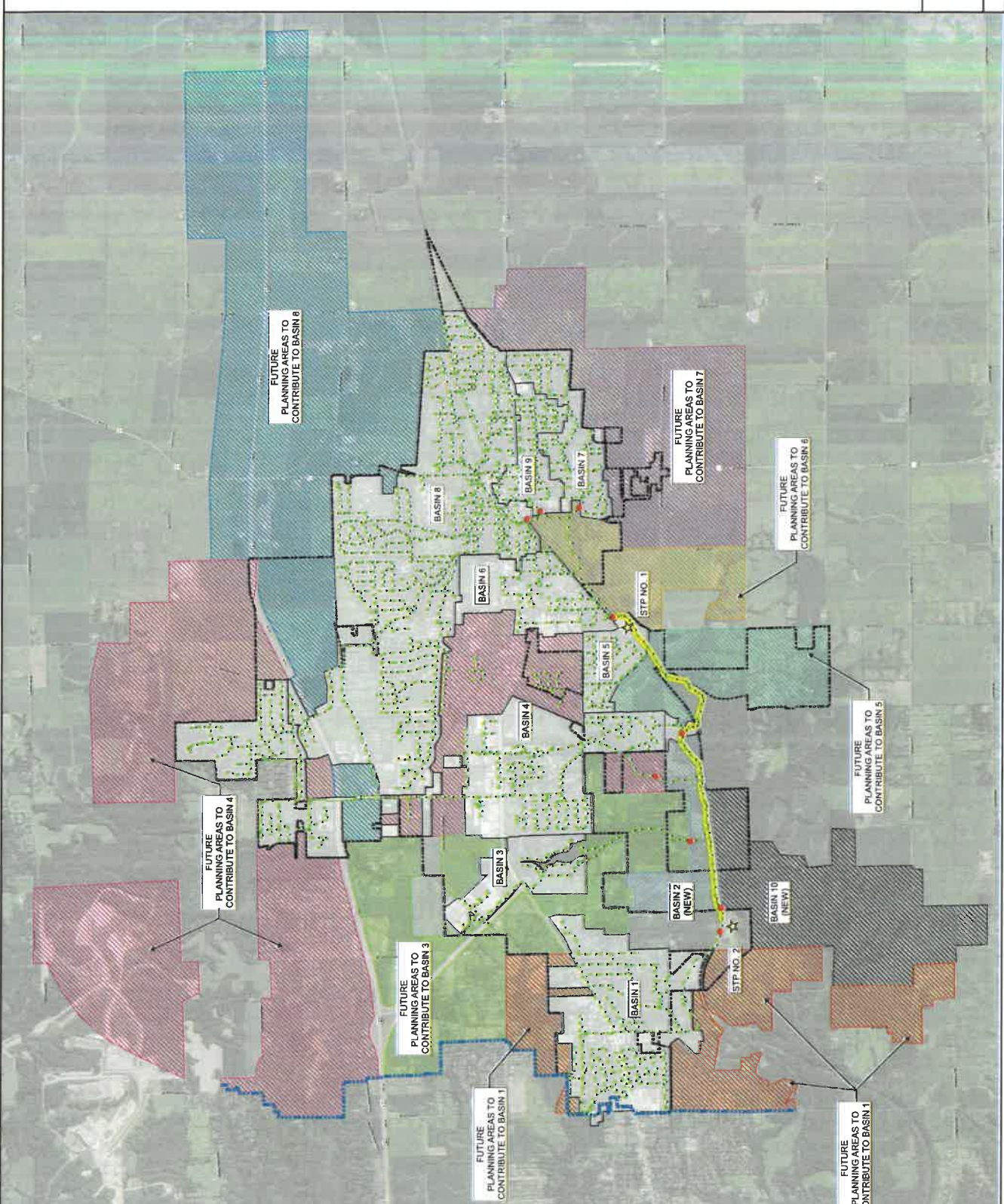

City of Washington
 Farm Creek Trunk Sewer Flow Schematic - Future Conditions

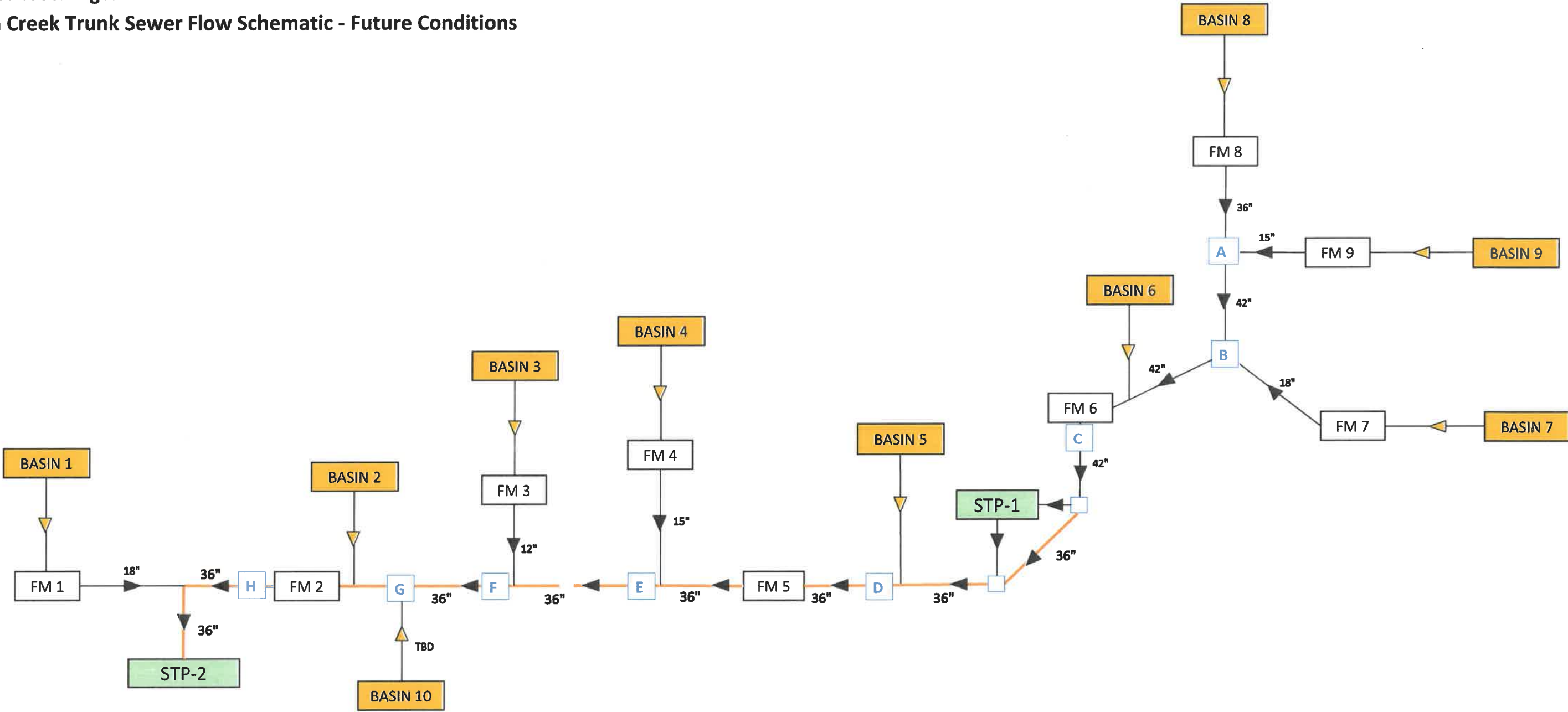

Figure 3.01-2 Future System Flow Schematic

Table 3.02-1 Theoretical Flow Calculations--Future Conditions

Flow Schematic	Additional Future PE	ADF (gpm)			Peaking Factor	DPF (gpm)			DMF (gpm)	
		Additional Future Average Flow	Existing ADF	Total Future ADF		Additional Future Peak Flow	Existing DPF	Total Future DPF	Existing DMF	Total Future DMF
Basin 8	35,384	2,457	636	3,093	2.41	5,915	3,610	9,525	9,584	15,499
Basin 9	6	0.45	78	78	4.43	1.99	622	624	3,391	3,393
Junction A	35,391	2,458	714	3,172	2.41	5,916	4,232	10,148	12,975	18,891
Basin 7	14,580	1,013	56	1,069	2.79	2,826	511	3,337	3,142	5,968
Junction B	49,971	3,470	770	4,240	2.26	7,859	4,743	12,602	16,117	23,976
Basin 6	4,009	278	166	444	3.33	928	585	1,513	585	1,513
Junction C	53,979	3,749	936	4,685	2.23	8,374	5,328	13,702	16,702	25,076
Basin 5	3,508	244	345	589	3.38	824	1,668	2,492	2,583	3,407
Junction D	57,487	3,992	1,281	5,273	2.21	8,818	6,996	15,814	19,285	28,103
Basin 4	9,650	670	349	1,019	2.97	1,990	639	2,629	909	2,899
Junction E	67,138	4,662	1,630	6,292	2.15	10,015	7,635	17,651	20,194	30,210
Basin 3	8,072	561	17	578	3.05	1,708	139	1,847	139	1,847
Junction F	75,210	5,223	1,647	6,870	2.10	10,993	7,774	18,767	20,333	31,326
Basin 10	699	49	-	49	3.90	189	-	189	-	189
Junction G	75,909	5,271	1,647	6,919	2.10	11,077	7,774	18,851	20,333	31,410
Basin 2	3,031	210	-	210	3.44	724	-	724	-	724
Junction H	78,939	5,482	1,647	7,129	2.09	11,438	7,774	19,213	20,333	31,772
Basin 1	3,259	226	179	405	3.41	772	641	1,413	2,290	3,062
STP-2	82,198	5,708	1,826	7,534	2.07	11,824	8,415	20,240	22,623	34,448
STP-2 (mgd)		8.22	2.63	10.85		17.03	12.12	29.15	32.58	49.60

Note: Grey rows represent trunk sewer features.

In Table 3.02-1, the additional future PE was used to determine the additional future ADF based on a contribution of 100 gpd per PE. This was then added to the Existing ADF to get the Total Future ADF.

A peaking factor was determined for the additional future PE which was then applied to the additional future ADF to get an additional future peak flow. This was added to the Existing DPF (July 6 flow conditions) to get the Total DPF. The additional future peak flow was also added to the Existing DMF to get the Total DMF.

B. New Trunk Sewer Design Capacity

The projected future flows presented in Table 3.02-1 were used to determine the design capacity needs for a new trunk sewer. Design of sewer systems are based on peak flows and not ADFs. For this study, the DPF was used as the basis for the trunk sewer design. The DMF was then used to determine how the system will react to the higher excess flow conditions.

Table 3.02-2 presents a proposed pipe size and slope to provide full-pipe flow capacity for the future DPF conditions.

Flow Schematic	Proposed Pipe Size (inch)	Minimum Slope ² (percent)	Pipe Capacity (gpm)	Percent of Pipe Capacity at ADF	Percent of Pipe Capacity at DPF
Basin 8	36	0.046	6,420	48.18	148.38
Basin 9	15	0.15	1,123	6.99	55.58
Junction A	42	0.036	8,566	37.02	118.46
Basin 7	18	0.12	1,633	65.44	204.33
Junction B	42	0.036	8,566	49.50	147.11
Basin 6 ¹	18	0.12	1,633	27.22	92.65
Junction C	36	0.30	16,394	28.58	83.58
Basin 5	8	0.40	343	171.62	726.69
Junction D	36	0.30	16,394	32.17	96.46
Basin 4	18	0.30	2,582	39.47	101.84
Junction E	36	0.35	17,708	35.54	99.68
Basin 3	18	0.12	1,633	35.37	113.09
Junction F	36	0.40	18,930	36.29	99.14
Basin 10 ¹	8	0.40	343	14.15	55.10
Junction G	36	0.40	18,930	36.55	99.58
Basin 2 ¹	12	0.22	750	28.06	96.50
Junction H	36	0.40	18,930	37.66	101.49
Basin 1	18	0.12	1,633	24.82	86.54
STP 1	36	0.50	21,165	35.60	95.63

Notes:

¹ Pipe size and slope are assumed

² Pipe slope on existing interceptor from Austin Engineering, all other slopes are assumed minimum per IEPA Title 35.

Grey rows represent trunk sewer features.

Table 3.02-2 Proposed Pipe Capacity for Future DPF Conditions

From this evaluation a minimum 36-inch nominal inside diameter pipe will be required to provide sufficient full pipe flow capacity for future flow conditions.

Table 3.02-3 presents a proposed pipe size and slope to provide full-pipe flow capacity for the future DMF conditions.

Flow Schematic	Proposed Pipe Size (inch)	Minimum Slope ² (percent)	Pipe Capacity (gpm)	Percent of Pipe Capacity at DMF
Basin 8	36	0.046	6,420	241
Basin 9	15	0.15	1,123	302
Junction A	42	0.036	8,566	221
Basin 7	18	0.12	1,633	365
Junction B	42	0.036	8,566	280
Basin 6 ¹	18	0.12	1,633	93
Junction C	42	0.30	24,729	101
Basin 5	8	0.40	343	993
Junction D	42	0.30	24,729	114
Basin 4	18	0.30	2,582	112
Junction E	42	0.35	26,711	113
Basin 3	18	0.12	1,633	113
Junction F	42	0.40	28,555	110
Basin 10	8	0.40	343	55
Junction G	42	0.40	28,555	110
Basin 2 ¹	12	0.22	750	97
Junction H	42	0.40	28,555	111
Basin 1	18	0.12	1,633	188
STP-1	42	0.50	31,925	108

Notes:
¹ Pipe size and slope are assumed
² Pipe slope on existing interceptor from Austin Engineering, all other slopes are assumed minimum per IEPA Title 35.
Grey rows represent trunk sewer features.

Table 3.02-3 Proposed Pipe Capacity for Future DMF Conditions

From this evaluation a minimum 42-inch nominal inside diameter pipe will be required to provide sufficient full pipe flow capacity for future flow conditions.

3.03 TRUNK SEWER ROUTE ALTERNATIVES

A. New Trunk Sewer Route Assumptions

In order to identify alternatives for trunk sewer routing and the resultant profile, some assumptions needed to be made at the STP 2 influent pumping station as shown on Figure 2.01-3 in Section 2.

1. Influent Pumping Station

The primary assumption was the starting elevation of the new trunk sewer. For this study, identification of a route and profile focused on minimizing modifications at the influent pumping station. It is understood the City will need to modify the station in the future as the projected future sanitary flows dictate, but the City's near-term financial burden would be reduced if significant modification to the station can be delayed until that need is actually realized.

As a rule of design, it is preferred the influent sewer to a pumping station be at or above the elevation for “all pumps on”, which in this case is 631.25.

Setting the elevation of the influent sewer below the all pumps on elevation creates some problems. The trunk sewer could be set as low as the station floor elevation of 625.0. But under this scenario approximately 1,700 feet of the trunk sewer will be surcharged before even the first pump turns on. If the new trunk sewer is set to the original design pump on elevation of 629.0 approximately 1,200 feet of the trunk sewer will be surcharged before the first pump turns on. The pump on settings at the station could be adjusted down to reduce surcharge, but would be limited by the pump hydraulics of the station.

Setting the new trunk sewer at the all pumps on elevation of 631.25 is only slightly lower than the existing trunk sewer elevation of 631.35 and maintains the current station operation. However, this raises issues relative to conflict with the existing trunk sewer.

2. Existing Trunk Sewer

Assessment of the existing trunk sewer upstream of the influent pumping station indicates that setting the new trunk sewer at the floor elevation of the influent pumping station (elevation 625.0) is the only option to avoid conflict at crossings of the existing sewer. Even at this starting elevation it is anticipated the new trunk sewer will be within 6 to 12 inches of the existing trunk sewer. The concern noted above is the surcharging that results from this elevation.

Generally, any higher starting elevation at the influent pumping station will require coordination of flows in the existing trunk sewer to maintain flows during construction. Temporary pumping could be very expensive so it is assumed that a special structure would be required to maintain the existing trunk sewer at crossings.

3. Sluice Gate Structure

As discussed in Section 2, the existing sluice gate structure was originally intended to control flows into the influent pumping station but is currently stuck in a half open position. It was assumed under this study the sluice gate structure would be removed and not replaced. As final design progresses, replacement of the sluice gate structure can be further assessed if the City would like to reestablish this flow control.

4. New Trunk Sewer Starting Elevation

For this preliminary engineering study, it was decided to evaluate potential routes and profiles with the new trunk sewer set to enter the influent pumping station at the current pump on elevation of 630.42. This minimizes surcharge in the new trunk sewer during normal operating conditions while providing enough depth for other conflicts upstream.

B. New Trunk Sewer Route Alternatives

The corridor between STP 1 and STP 2 was evaluated to determine feasible routes for a new trunk sewer at the size and slope required to provide sufficient capacity for future flow conditions. Two general route alternatives were identified.

1. Alternate Route A

Appendix A provides preliminary engineering plan and profile drawings for Alternative Route A. This route is generally considered the northern route because it is primarily north of the Toledo, Peoria, and Western Railroad right-of-way (ROW). The key feature of this route is that it mostly follows the same route as the existing trunk sewer.

The positive aspects of this route include the following:

- a. Relatively shallow excavation depths—Compared to Route B, the Route A alternate is able to maintain shallower depths because of its proximity to the low creek valley. However, there are a couple stretches over 20 feet in depth and up to 30 feet in depth in order to provide sufficient cover over the trunk sewer at creek crossings.
- b. Potential easement transfer—This route is not exactly the same as the existing route, but it is close, which could make negotiation of easements for the new trunk sewer easier. It is anticipated that there are seven property owners that will need to grant a new easement, which would include elimination of the old easement and might be seen as a simple easement transfer from the property owners.
- c. Tributary sewer connections—Because this route follows the existing route, it allows for the easiest connection of existing tributary sewers. And, because it

is mostly on the north side of the railroad, it is accessible for future new tributary sewer connections.

- d. Railroad crossings—This route has two railroad crossings for the new trunk sewer as compared to Route B that has three crossings. However, the Route B crossings are not for the trunk sewer but are for the smaller diameter tributary sewers.

The negative aspects of this route include the following:

- a. Proximity to the creek—Similar to the existing trunk sewer, this route is susceptible to I/I from the creek and high groundwater. In developing this route, the emphasis was on moving the trunk sewer away from the creek without taking too much private property and locating manholes where they would be accessible to the City for maintenance. However, this route is still mostly in the Farm Creek flood plain and crosses the creek no less than 15 times.
- b. Shallow cover at creek crossings—It is desirable to maintain at least 5 feet of cover over the top of the trunk sewer to the bottom of the creek at all creek crossings. At the assumed starting elevation this route has 10 crossings with less than 5 feet of cover, and most have less than 2 feet of cover. For this route to be practical, the starting elevation of the trunk sewer will have to be dropped lower, which creates issues as discussed previously. Furthermore, cursory survey investigations performed for this study indicate the creek location is different and the bottom elevation may be lower than shown on the drawings derived from the most recent laser identification detection and radar data. Survey of the proposed corridor will need to be performed during final design to verify sufficient cover is provided.
- c. Permitting—Because of the proximity of this route to the creek, it is in the Farm Creek flood plain and poses wetland and other environmental impacts. This will require significant environmental permitting and possibly more stringent construction requirements.
- d. Creek boring and jacking—It is anticipated that environmental permitting for this route may require boring and jacking the new trunk sewer to minimize impacts to the creek. In that case, there would be as many as 15 bore and jack crossings of the creek.
- e. Manhole inaccessibility—This route endeavored to make as many manholes accessible to the City for maintenance. But in order to achieve maintainable lengths of sewer between manholes there are still some manholes that will require creek crossing to access.

- f. Conflicts with existing trunk sewer—Because this route generally follows the existing trunk sewer it also crosses the existing trunk sewer in several locations. Where conflicts are unavoidable, special structures could be designed to maintain the existing trunk sewer otherwise bypass pumping will be required. Following construction, the existing trunk sewer connections to special structure would be removed.
- g. Longer route—This route is longer and has more manholes than Route B.
- h. Clearing and grubbing—Both routes will require significant clearing and grubbing of existing trees and brush.

2. Alternate Route B

Appendix B provides preliminary engineering plan and profile drawings for Alternate Route B. This route is generally considered the southern route because it is primarily south of the Toledo, Peoria, and Western Railroad ROW. The key feature of this route is that it mostly avoids the creek and conflicts with the existing trunk sewer.

The positive aspects of this route include the following:

- a. Distance from the creek—Unlike the other route and the existing trunk sewer, this route does not follow the creek. A major consideration for this project was to provide the City with a new, reliable trunk sewer that minimizes the potential for excess flow into the system. This route best meets that goal by reducing the new trunk sewer's susceptibility to I/I from the creek and potentially from high groundwater.
- b. Sewer accessibility—Another major consideration was to provide the City with a new trunk sewer that would be accessible for maintenance. Because this route does not have to contend with the serpentine alignment of the creek it presents a good location for the City to gain continual access. As much as possible, this route endeavored to provide a straight alignment, generally following the railroad, which should be less intrusive to the property it crosses and less impactful to the landscape in creating and maintaining a cleared access corridor.
- c. Railroad crossings—This route has three railroad crossings, but they are smaller diameter and less costly per foot as compared to the two Route A crossings.
- d. Permitting—Because this route is mostly away from the creek it is also mostly outside of the Farm Creek flood plain and reduces potential wetland and other environmental impacts. This will reduce environmental permitting construction requirements.

- e. Creek boring and jacking—This route only has two creek crossings that may require boring and jacking the new trunk sewer to minimize impacts to the creek.
- f. Conflicts with existing trunk sewer—This route almost completely avoids the existing trunk sewer, and where it does cross the existing trunk sewer there is flexibility in elevation that provides feasible options to keep the existing sewer in service throughout construction.
- g. Shorter route—This route is shorter and has less manholes than Route B.

The negative aspects of this route include the following:

- a. Shallow cover at first creek crossing—This route almost completely avoids the creek, except at the west end with one creek crossing. At the proposed starting elevation of 631.25 results in the trunk sewer being exposed at the creek crossing. However, the pipe could be constructed below the existing ford in the creek at this crossing location. In any case, additional structural protection will be required for the trunk sewer at this creek crossing
- b. Relatively deep excavation depths—Because this route does not follow the creek, it is located in higher ground; this results in deeper excavations. In general, the depth of excavation is between 10 feet and 20 feet with a few stretches between 25 feet to 30 feet.
- c. Boring and jacking sewer—There are four locations where the trunk sewer depth exceeds 50 feet. It is intended in these areas for the sewer to be installed by boring and jacking, which adds to the construction costs.
- d. Easements—This route is mostly on entirely new property, which will require the City to obtain new easements. However, there are only three property owners that will need to grant easements as opposed to seven required for Route A, and two of the property owners for Route B already have the existing trunk sewer on their property and might actually be considered an easement transfer.
- e. Tributary sewer connections—Because this route is on the south side of the railroad, it is separated from most of the City's current and future development. This will require new bore and jack sewers across the railroad to connect the existing collector sewers. This will also require future collector sewers to cross the railroad to access the new trunk sewer.
- f. Clearing and grubbing—Both routes will require significant clearing and grubbing of trees and brush.

3.04 TRUNK SEWER MODELING

A series of dynamic hydraulic models were created using Bentley Sewer Gems to assess flow conditions in the new trunk sewer for both Route A and Route B. Exhibits of the modeling results are provided in Appendix C and include the following scenarios.

1. Existing Flow Conditions–No STP 2 Modifications

The existing flow conditions in the new trunk sewer were modeled to generally provide an indication of how the new trunk sewer would operate if the sluice gate and influent pumping station were not improved. This was only done for Route A.

- a. Route A–Existing ADF with existing sluice gate and current pumping station capacity.
- b. Route A–Existing DPF with existing sluice gate and current pumping station capacity.
- c. Route A–Existing DMF with existing sluice gate and current pumping station capacity.

This modeling indicates that under existing conditions the level in the wet well reaches elevation 632.0 during ADF conditions, which means that all three raw sewage pumps are required during the daily peak flow periods. Furthermore, flow conditions during the July 6 storm event (DPF) and the August 30 storm event (DMF) result in wet well levels of 635.2 and 639.8, respectively. For the August 30 event this would have been 10 feet below the top of the influent pumping station.

2. Future Flow Conditions–No STP 2 Modifications

To provide an indication of the system conditions without improvements made to STP 2, Route A was modeled under future ADF conditions using the current influent pumping station capacity and the sluice gate still in place.

- a. Route A–Future ADF with existing sluice gate and current pumping station capacity.

This model indicates under current influent pumping station capacity the storm pumps would be required to handle the future ADF conditions.

3. Future Flow Conditions–With STP 2 Modifications

Route A and Route B were both modeled under future ADF, DPF, and DMF conditions for a new 36-inch-diameter pipe with the assumption the sluice gate structure will be

removed and the capacity at STP 2 and the influent pumping station will be increased to serve the future conditions.

- a. Route A–Future ADF–36-inch pipe
- b. Route A–Future DPF–36-inch pipe
- c. Route A–Future DMF–36-inch pipe
- d. Route B–Future ADF–36-inch pipe
- e. Route B–Future DPF–36-inch pipe
- f. Route B–Future DMF–36-inch pipe

Based on the full-pipe flow results discussed in Section 3.02, it was anticipated that both routes would be able to handle the DPF (See Appendix C, Figures f and i), but would not be able to handle the DMF (See Appendix C, Figures g and j). Both of the routes were then modeled with a 42-inch pipe for DPF and DMF.

- g. Route A–Future DMF–42-inch pipe
- h. Route B–Future DMF–42-inch pipe

3.05 SEWER TREATMENT PLANT MODIFICATIONS

The preliminary engineering aspects of this study endeavored to minimize required modifications to the STPs. Following is a discussion of the modifications that may be required depending on the trunk sewer design and routing alternatives selected.

A. STP 1

The City is required to decommission STP 1. The new trunk sewer would require a new junction structure upstream of Control Chamber No. 1 to maintain the existing trunk sewer during construction and allow for redirection of flows upon completion of construction. This new junction structure and trunk sewer would completely separate flows from STP 1 and allow the City to decommission the plant.

However, as an alternate, the City may want to consider maintaining Control Chamber No. 1 to allow for excess flow bypass and storage on the decommissioned STP 1 site.

B. STP 2

The projected future flow conditions for the City indicate that at some time in the future the City will need to make capacity improvements at STP 2, but those improvements may not be necessary as part of the new trunk sewer project. The City may choose to delay improvements at STP 2 to a later time, so the intent of this study is to provide preliminary design of a new trunk sewer while minimizing modifications required at STP 2, and specifically the influent pumping station.

As presented in this study, the modifications at STP 2 are anticipated to be at the influent pumping station with a new penetration into the wet well at an elevation determined with the City.

SECTION 4
INFLUENT PUMPING AND EXCESS FLOW EVALUATION

4.01 INTRODUCTION

The plans for the new Farm Creek Trunk Sewer (Alternate B Plan and Profile) anticipate a new 42-inch sewer crossing below Farm Creek and entering the east side of the wastewater treatment plant (WWTP) at a significantly lower elevation than the existing WWTP influent pumping station wet well. Refer to Appendix B Sheet B-1 Alternate B Plan and Profile for a preliminary plan and profile of this sewer. Assuming this influent sewer profile, the new Farm Creek interceptor sewer would be approximately 3.25 feet lower than the floor of the existing WWTP influent pumping station wet well. This requires influent pumping station modifications to accommodate the new influent sewer.

The Preliminary Engineering Study for the Farm Creek Trunk Sewer included flow monitoring and evaluation of influent flows in the interceptor sewer system. This flow data was reviewed along with WWTP record documents to assess flows to the WWTP influent pumping station. See Table 4.01-1 for a summary of influent flows. This table lists current dry weather flows, ADF, DPF, and DMF to the WWTP from the new interceptor sewer system that were evaluated and developed in Sections 2 and 3 of this report.

Flow Condition	Total Flow to WWTP (mgd)	Forward Flow to WWTP ³ (mgd)	Excess Flow to Lagoon (mgd)
Dry Weather Minimum Flow ¹	1.09	1.09	0.00
Existing Average Dry Weather ¹	1.73	1.73	0.00
Existing ADF ²	2.63	2.63	0.00
Total Future ADF ^{2, 4}	10.85	7.48	3.37
Existing DPF ²	12.12	7.48	4.64
Total Future DPF ²	29.15	7.48	21.67
Existing DMF ²	32.58	7.48	25.10
Total Future DMF ²	49.60	7.48	42.12

Notes:

- ¹ Dry weather flow values obtained from Table 2.02-1 of Preliminary Engineering Study for the Farm Creek Trunk Sewer.
- ² Flow Conditions and Total Flow values obtained from Table 3.02-1 of Preliminary Engineering Study for the Farm Creek Trunk Sewer.
- ³ 7.48 mgd is the current forward flow capacity of the WWTP (influent pumping capacity). Forward flow capacity and influent pumping capacity may be increased with future facility planning and expansion. Refer to Section 4.02 for additional information.
- ⁴ Total future ADF is based on the ultimate growth of the facility planning area. Refer to Section 3 for further information.

Table 4.01-1 Influent Flow Summary

4.02 INFLUENT PUMPING STATION

Several influent pumping station options were evaluated to accommodate the proposed new influent sewer location and elevation as well as anticipated flows. Also taken into consideration were the WWTP's current problems including rags and clogging of the existing influent sewage pumps and the

existing Sluice Gate Structure gate that is stuck in a partially open position. The existing site layout, electrical, and other site elements were reviewed as part of this evaluation.

Our analysis determined the recommended option of a new submersible influent pumping station to receive and convey flow from the proposed new interceptor configuration. The new submersible pumping station is anticipated to include four new submersible pumps sized to convey the rated forward flow capacity of the WWTP (7.48 mgd) to the existing Screening Building with one pump out of service. This submersible pumping station would replace the existing influent pumps in their entirety. Flows exceeding 7.48 mgd during high-flow events would be diverted to the Excess Flow Pumps. A preliminary hydraulic analysis indicates that the excess flows can be conveyed to the existing influent wet well via an overflow weir and gravity sewer where the existing excess flow vertical turbine pumps (storm pumps) would pump the excess flow to the existing storage lagoon. Table 4.01-1 summarizes excess flows to the lagoon under various conditions. Excess flow handling and analysis will be further discussed later in this section.

The new submersible pumping station is anticipated to be comprised of the following elements:

- A common influent junction chamber to receive the new interceptor sewer and existing WWTP sewer piping rerouted to this location.
- The common influent junction chamber is anticipated to include a fixed sharp-crested weir overflow and outlet box to divert excess flows greater than 7.48 mgd to the existing Excess Flow Pumping Station.
- A total of four new submersible pumps configured in a split wet well (two pumps in each wet well chamber). Sluice gates would be provided to control flow from the common influent junction chamber to each pump wet well. This allows for isolation of pump wet wells for cleaning or maintenance.
- A common valve vault to house check valves, isolation valves, and other control valves and force main piping.
- The common influent junction chamber and valve vault can be provided with emergency bypass pumping connections and piping to allow a portable pump and hoses to be connected to the pumping station should there be a problem with the submersible pumps requiring isolation or bypass.
- It is anticipated the new submersible pumps would be driven by variable frequency drives (VFDs). The new pumping station would be integrated with the WWTP supervisory control and data acquisition (SCADA) system and controlled via submersible level transducers with backup float switch level control.

A preliminary evaluation and layout of the new submersible pumping station, piping, and related site work was performed. Figures 4.02-1 and 4.02-2 illustrate anticipated demolition work on the site and in the existing Control Building to accommodate the new pumping station improvements. Figures 4.02-3

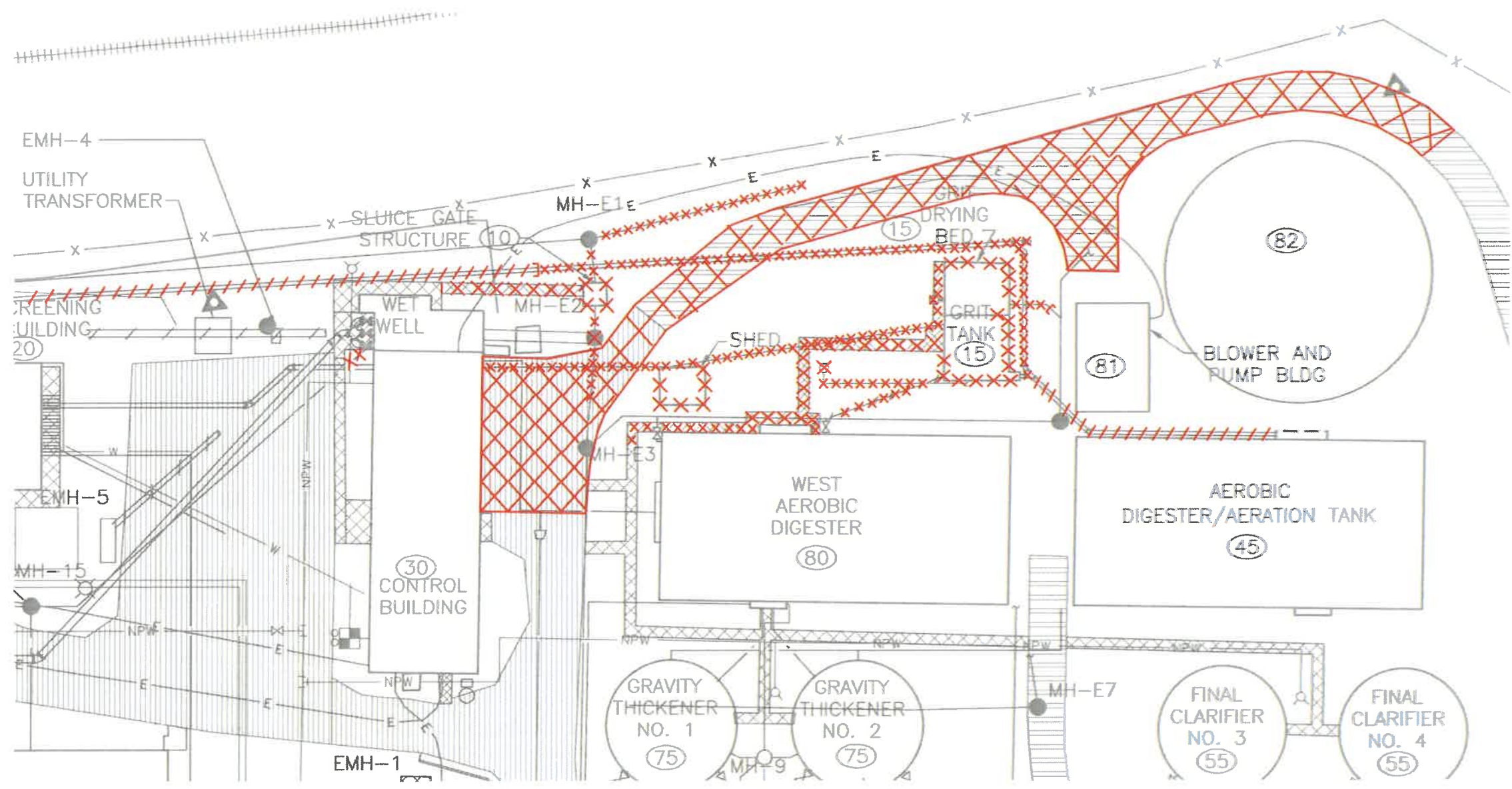

Site Demolition Plan
(no scale)



SITE
DEMOLITION PLAN
 FARM CREEK TRUNK SEWER
 PRELIMINARY ENGINEERING STUDY
 CITY OF WASHINGTON
 TAZEWELL COUNTY, ILLINOIS



FIGURE 4.02-1
1879.025

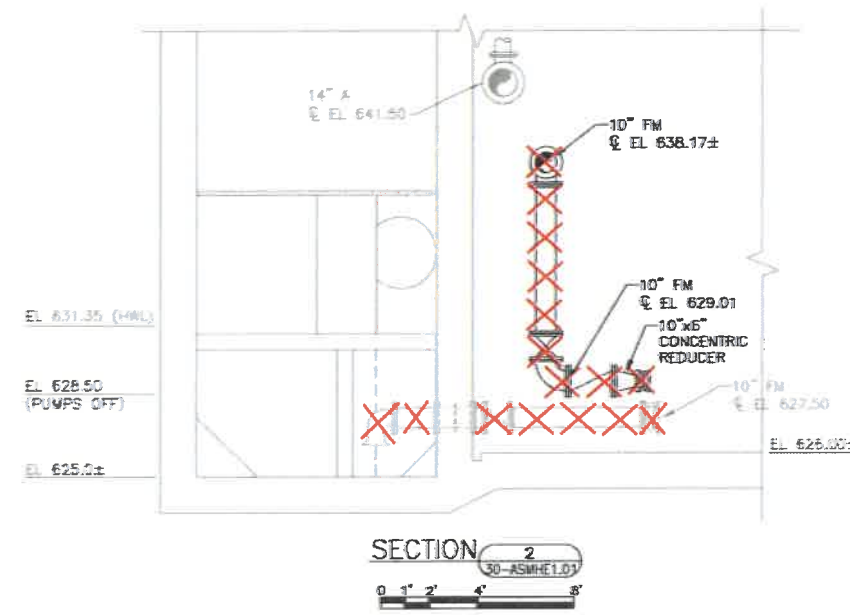
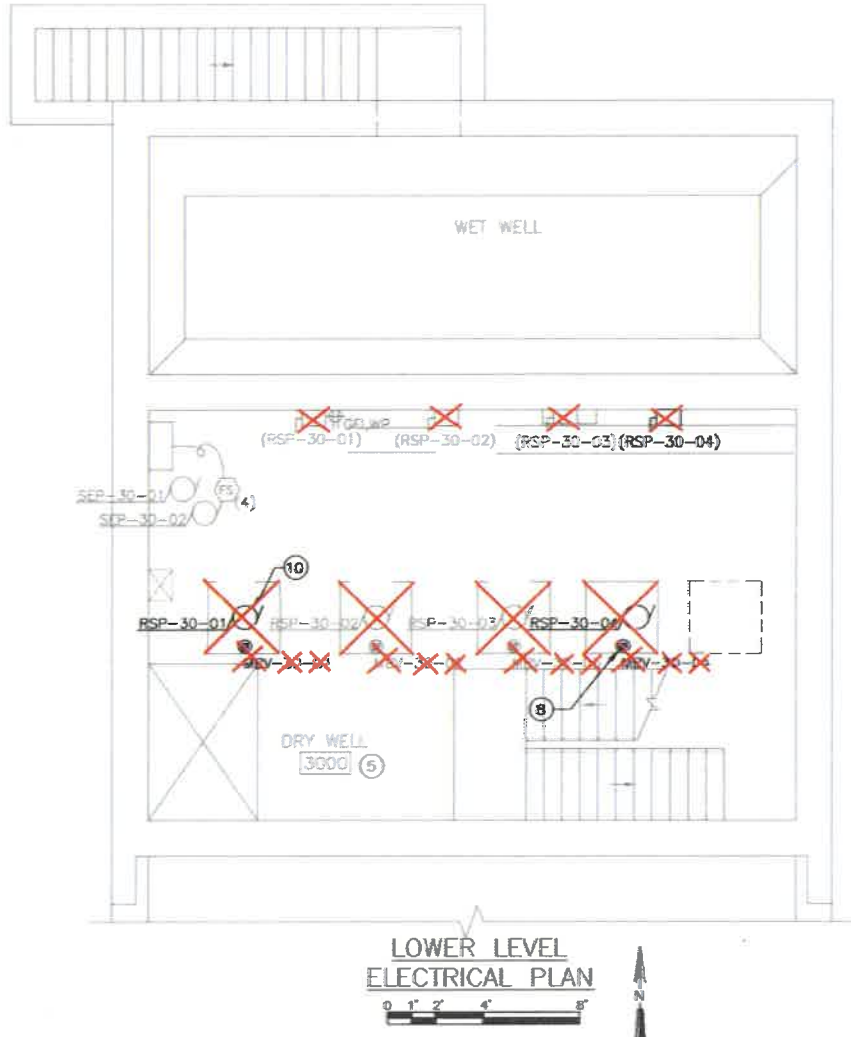
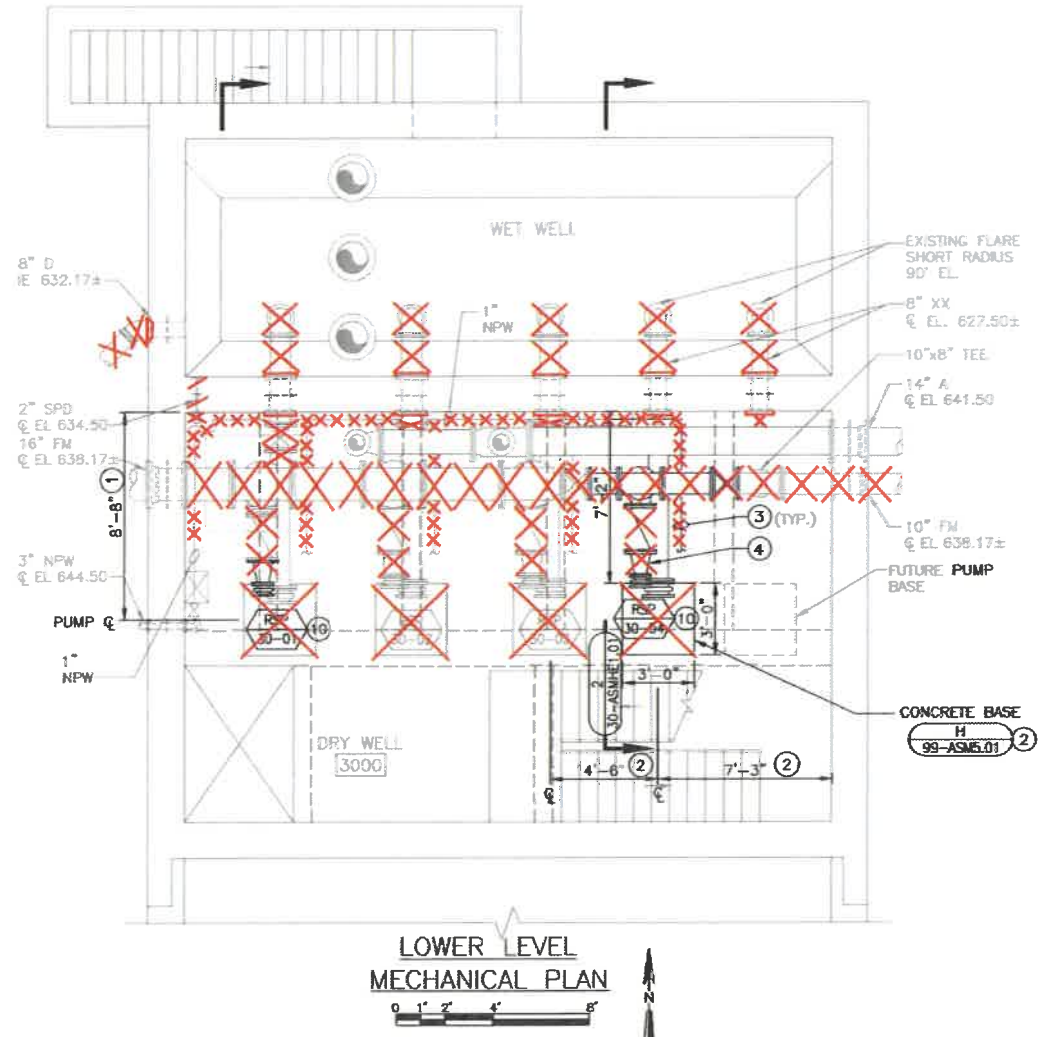
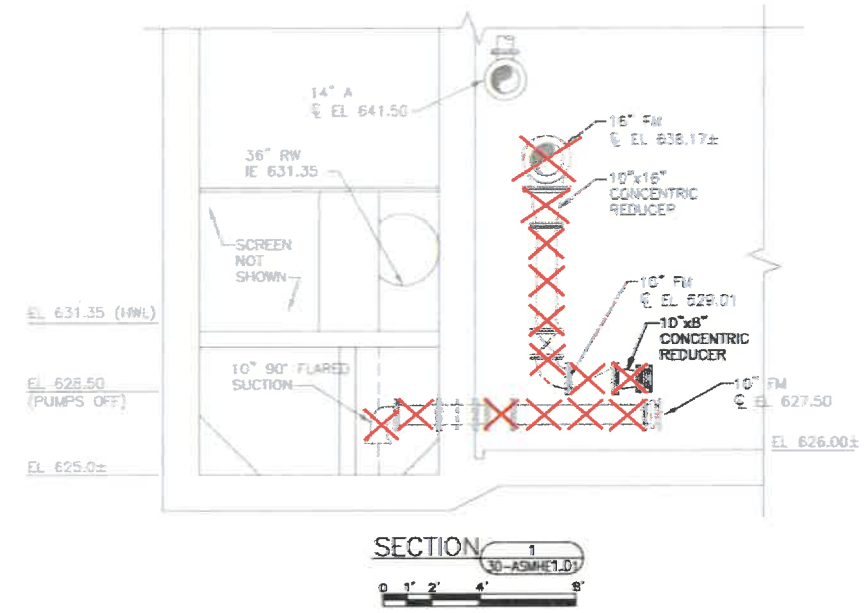
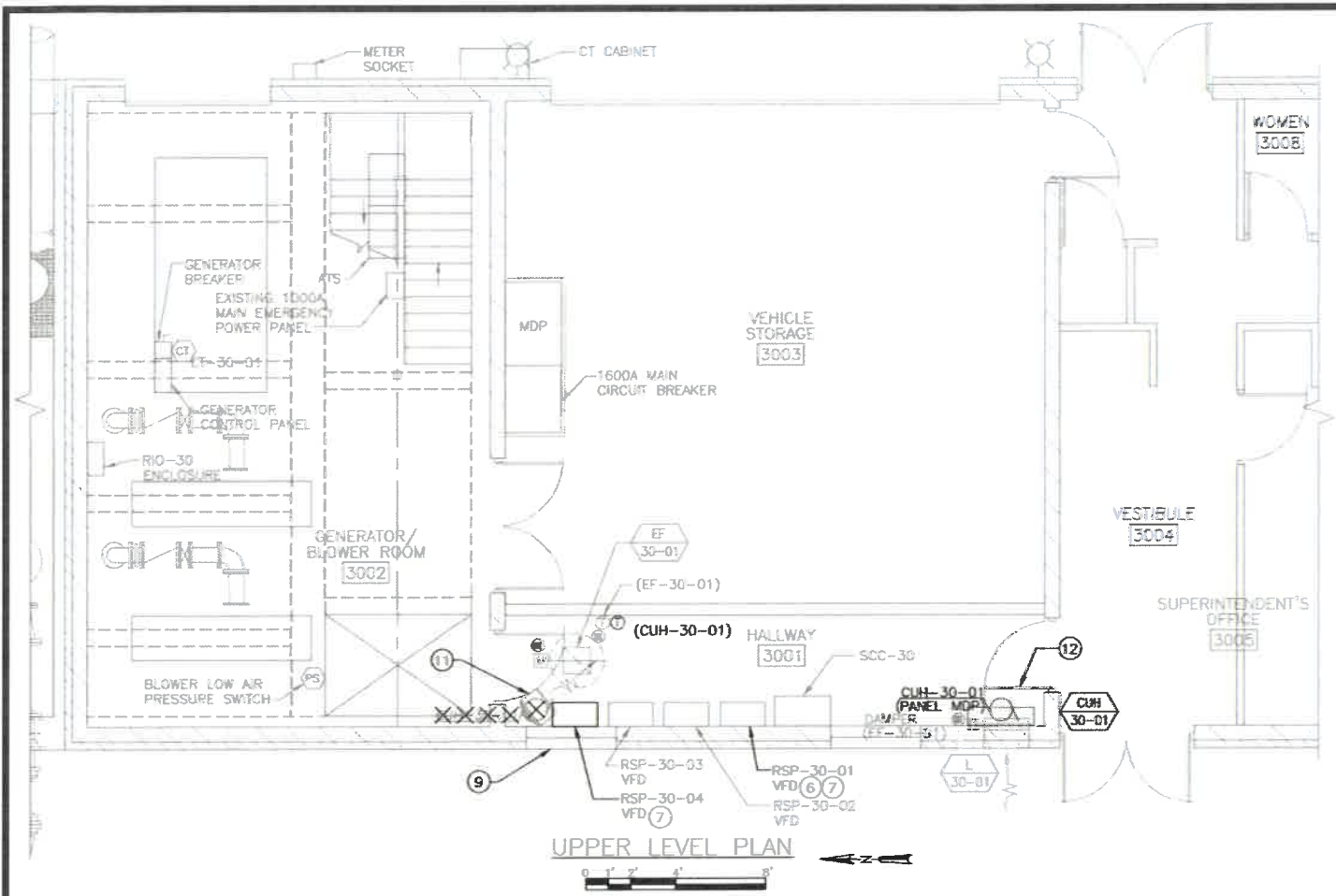

**CONTROL BUILDING
DEMOLITION PLANS AND SECTIONS**
FARM CREEK TRUNK SEWER
PRELIMINARY ENGINEERING STUDY
CITY OF WASHINGTON
TAZEWELL COUNTY, ILLINOIS



FIGURE 4.02-2
1879.025

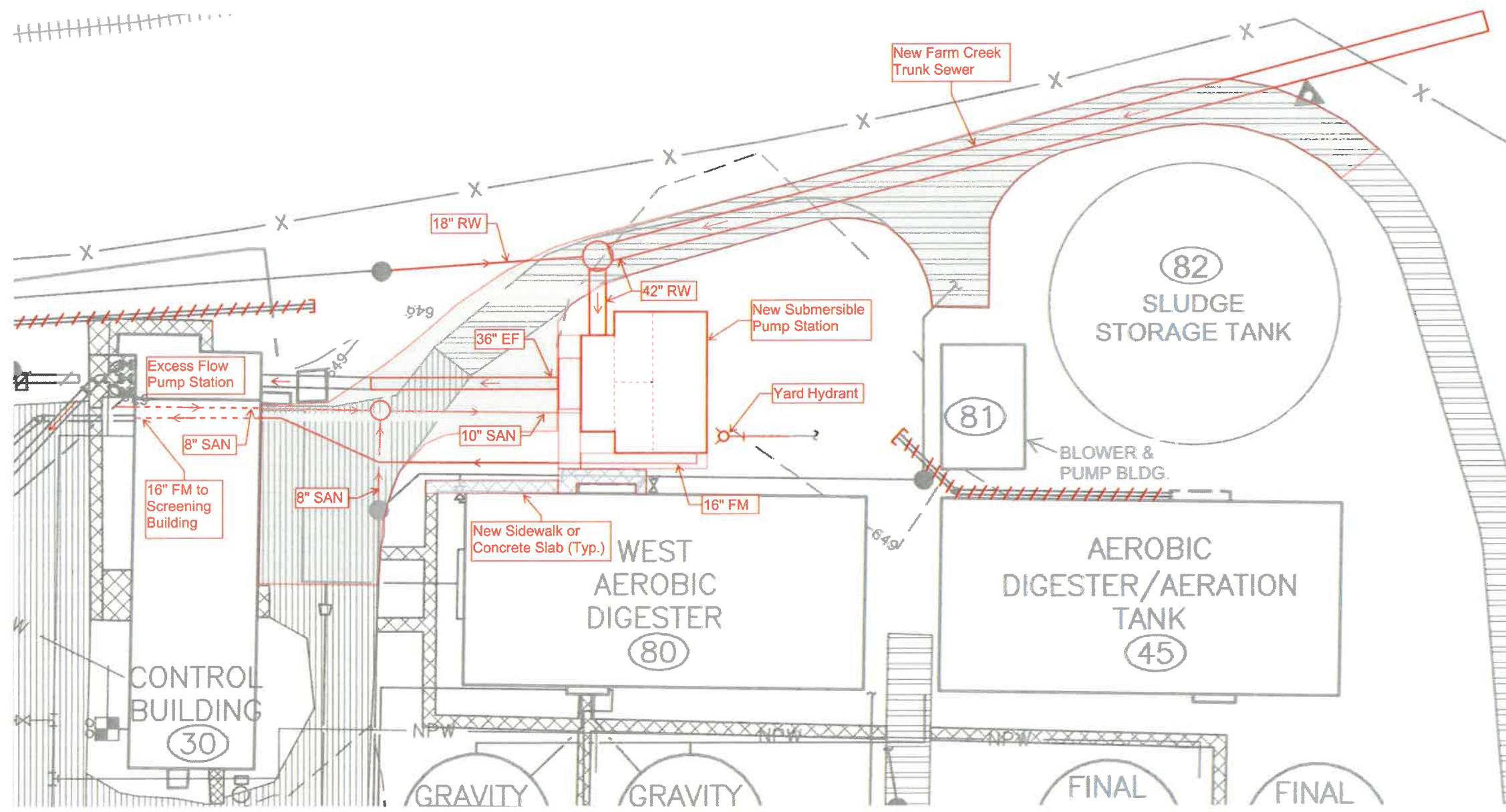

Site Plan
(no scale) ↑ North

SITE
PROPOSED PLAN
 FARM CREEK TRUNK SEWER
 PRELIMINARY ENGINEERING STUDY
 CITY OF WASHINGTON
 TAZEWELL COUNTY, ILLINOIS



FIGURE 4.02-3
 1879.025

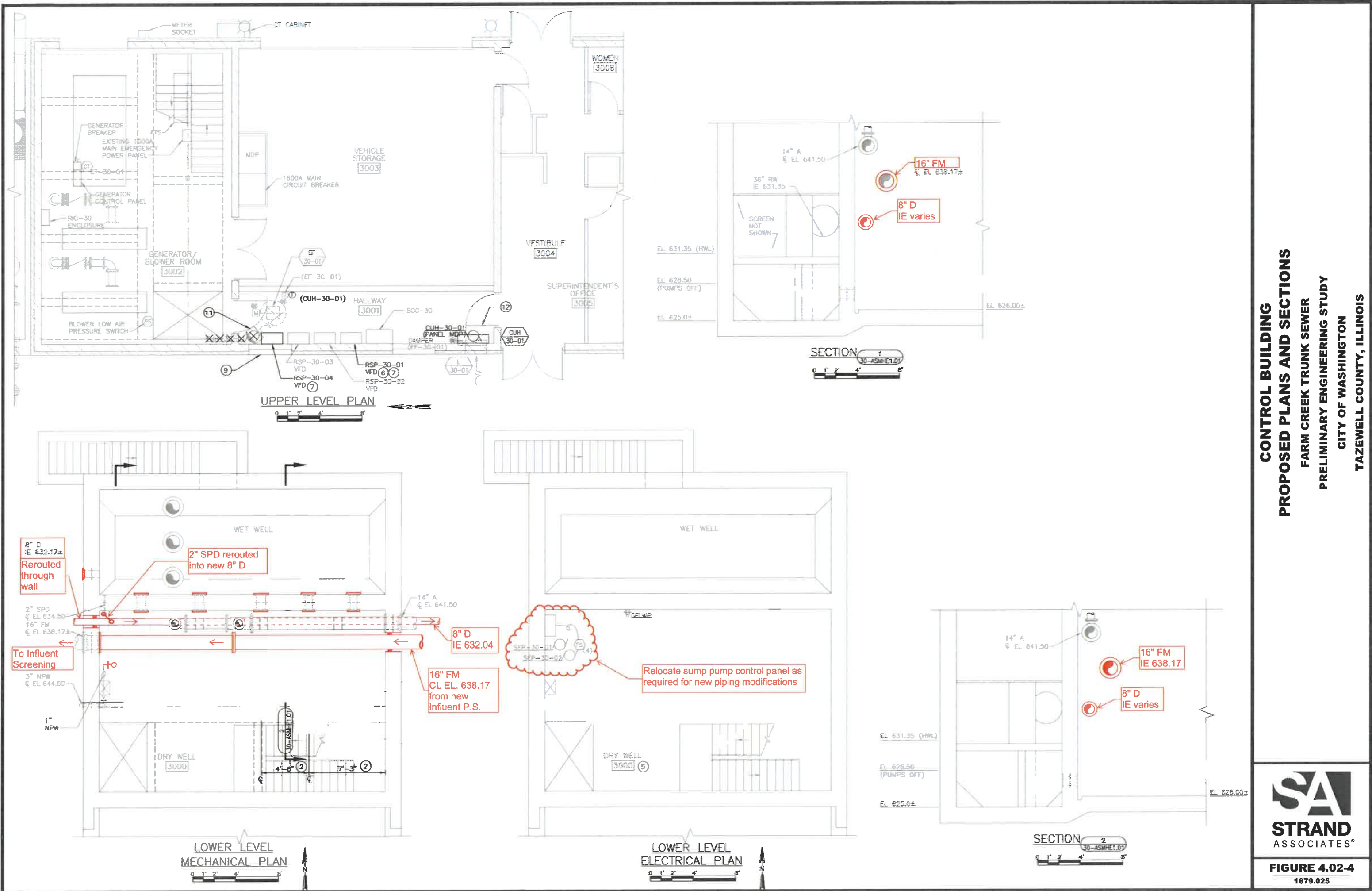

CONTROL BUILDING
PROPOSED PLANS AND SECTIONS
 FARM CREEK TRUNK SEWER
 PRELIMINARY ENGINEERING STUDY
 CITY OF WASHINGTON
 TAZEWELL COUNTY, ILLINOIS



FIGURE 4.02-4
1879.025

and 4.02-4 provide a site plan showing potential layout of the new submersible pumping station, piping, manholes, and associated modifications to the Control Building.

As shown in the attached figures, the location of the new submersible pumping station is proposed north of the West Aerobic Digester. Demolition of buildings and piping will be necessary in this vicinity to accommodate construction of the new pumping station. The existing influent pumps, piping, and appurtenances would be removed from the existing pumping station as shown. Given existing site features and existing buried electrical and piping, it appears the most cost-effective route for the new pumping station force main and piping will be through the Control Building connecting to the existing 16-inch force main as shown. This would eliminate difficult and costly excavation and installation via other routes. Similarly, it appears feasible to reroute the existing WWTP drain and sewer piping from the west side of the WWTP to the east side of the WWTP in a parallel route to the new influent pumping station. With this scenario, a new excess flow pipe is expected to be routed from the overflow box on the common influent junction chamber west to the existing influent pipe to the Excess Flow Pumping Station wet well. The existing wet well would thus be converted to a dedicated excess flow station. Provisions would need to be made to temporarily remove and relocate the existing generator fuel tank on the east side of the existing wet well to accommodate the construction. It also appears there is a pad-mounted radiator for the engine generator in this vicinity that will need to be temporarily braced, protected, or otherwise dealt with to allow the pipe work in this area.

The depth of the new submersible pumping station wet well is anticipated to be in the range of 34 to 37 feet to accommodate the elevation of the new interceptor sewer and allow for recommended submergence and operating range of the new submersible pumps. Therefore, it is anticipated significant sheeting or shoring systems will be needed to construct the junction chamber, wet well and some of the associated piping. Construction sequencing and bypass pumping and/or piping needs will also be significant considerations for the construction.

Preliminary hydraulic calculations were performed for the new submersible pumping station preliminary design and layout. Xylem—Flygt Model NP-3202.095, 35 horsepower (hp) submersible pumps were selected based on the hydraulic conditions and operating ranges. The pumps have a full-load rated current of 42 amps and appear to have very good operating efficiency for the anticipated system conditions.

The Xylem—Flygt Model NP pumps also have a proven track record of handling raw wastewater solids and rags without clogging. Therefore, not only is it anticipated there may be an improvement in pumping efficiency as compared to the existing pumps, but pump operation is expected to inherently be better given the existing pumps' tendency to consistently clog with rags or other wastewater debris.

Considering the rated current of the new submersible pumps selected for this design, preliminary analysis indicates that the existing VFDs could potentially be reused to control the new pumps because the rated current of the existing raw sewage pumps is significantly higher than the selected submersible pumps. New wiring in buried conduits would be installed from the VFDs in the Control Building to the new submersible pumping station. Local disconnect switches and junction boxes would be provided at the new submersible pumping station as required. New level controls and SCADA control programming would be implemented to provide efficient control of the new pumping station.

The existing standby power generator was also checked versus the submersible pump loads. Although the existing standby generator capacity is limited, it is expected that it would support the new submersible pumps without issue because the existing raw sewage pumps that are being removed with this option appear to currently be a higher load on the generator resulting in a net lower power demand for the generator.

It should be noted that backwater check valves or similar backflow protection devices may need to be installed on the WWTP sewer piping that is rerouted to the new submersible pumping station to ensure no sewage backs up in the plant sewer system because of the excess flow levels anticipated in the wet well. The need for these types of valves and location should be further evaluated during design.

As discussed earlier in this section, the preliminary design of the new influent submersible pumping station anticipates a firm capacity of 7.48 mgd (with three pumps running and one pump out of service), with higher flows beyond the firm capacity of the pumping station diverted to the excess flow facilities. The current forward flow capacity (DMF) of the WWTP is 7.48 mgd. It appears the WWTP facilities will require comprehensive and significant improvements in multiple areas to provide treatment capacity for the projected future design flows of the new interceptor sewer system (future ADF, DPF, and DMF). The new influent submersible pumping station design should accommodate future expansion to increase its capacity beyond 7.48 mgd for future influent flows to the WWTP coordinated with overall WWTP facility plans. The future forward flow capacity of the WWTP facilities will directly affect the future firm capacity needs of the influent pumping station.

Therefore, at this time, it is anticipated and recommended that the new influent pumping station be designed with a firm capacity of 7.48 mgd, with additional wet well volume to accommodate larger pumps and/or the addition of pumps as required to meet future demands. This may be accomplished by sizing the pump wet wells large enough to accommodate bigger pumps in the future with fillets or baffles to provide the recommended internal wet well geometry for the new pumps that will be installed to meet current or near-term demands. The wet wells may also be designed and constructed with additional volume and knockouts or fillets that can be removed in the future to add additional pumps, piping, and valves to increase the pumping capacity of the pumping station. The split wet well concept, as contemplated in the preliminary pumping station design, allows for isolation of one side of the wet well while keeping the rest of the pumping station in service, which would help to accommodate the future construction and expansion of the pumping station. The sizing and configuration of the force main piping and valve vault can also be designed for future capacity increases as deemed appropriate. Electrical design provisions should be considered to accommodate future expansion, for instance to accommodate additional pump VFDs and/or larger pump motors. Because the existing power at the WWTP is limited, additional power will likely be needed in the future if pumps are upsized or added to the pumping station.

Further WWTP facilities planning efforts, and additional evaluation of design flows for the influent pumping station, are recommended to better determine the future design criteria and sizing for the influent pumping station to accommodate future expansion. For the purposes of this evaluation and planning efforts at this time, it was assumed the pumping station would be preliminarily designed with added wet well and valve vault volume to allow expansion from a four-pump station to a six-pump station with the addition of larger pumps for increased capacity in the future, avoiding the need for deep

excavation to expand the wet wells in the future. The size and configuration of the station would need to be finalized and confirmed with further planning.

4.03 EXCESS FLOW EVALUATIONS

A. Excess Flow Pumping

With the new submersible pumping station option described above, excess flows to the WWTP were also evaluated. Table 4.01-1 shows the excess flows that would be diverted to the proposed Excess Flow Pumping Station and transferred to the lagoon under various flow conditions. The Excess Flow Pumping Station is proposed to occupy the existing wet well in its entirety.

According to the design criteria of WWTP record drawings, the existing Excess Flow Pumping Station has a capacity of 12,400 gpm (17.86 mgd) with three vertical turbine pumps running. This appears to be adequate capacity to handle the existing excess DPF (4.64 mgd), but capacity appears inadequate for the existing DMF (25.10 mgd).

The existing Excess Flow Pumping Station capacity is also less than the projected total future DPF and DMF as shown in Table 4.01-1. Therefore, the Excess Flow Pumping Station would require modifications to meet these projected future flow demands. To meet this demand, we have proposed replacing the existing vertical turbine pumps with new vertical turbine pumps to eventually meet the future DMF. Consideration should also be given to the replacement of the existing 24-inch diameter excess flow force main or the addition of a parallel force main. This needs to be considered because of resulting high flow velocities and corresponding dynamic head conditions at these flowrates. However, for the purposes of this report, the force main is not proposed to be replaced because the excess flow rate is infrequent, and the motor horsepower was increased to accommodate the additional velocity head.

It is important to note the following regarding the existing Excess Flow Pumping Station:

- According to our records, one of the three existing excess flow pumps is currently not backed up on standby (generator) power. Two of the pumps are wired to the standby power system, while the third is not.
- The existing standby power (generator) is limited near its capacity under current loads. Therefore, adding the additional load of more excess flow pumps would likely require modification or replacement of the standby power system. Replacement costs of the generator are beyond the scope of this report and not included in the opinion of probable cost.
- The existing main electrical distribution system (power feed to the WWTP) is limited and near capacity. Some capacity may be created by the replacement of the existing influent pumps with the more efficient submersible pumps noted earlier; however, this is likely not enough of a difference to support the addition of one or more excess flow pumps to the overall load. The addition of more excess flow pumps would result in the likelihood of increasing capacity of the electrical feed and distribution system to the WWTP. These electrical costs are not included in

the OPCC. However, there is electrical capacity for the Phase 1 Excess Flow Improvements discussed in the following.

The pumps proposed for the excess flow facilities have been sized based on the future DMF of 49.6 mgd, less the plant forward flow pumps (7.48 mgd), which is 42.12 mgd (29,250 gpm) with four pumps in operation with no redundancy.

The Excess Flow Pumping Station pump design criteria is summarized in Table 4.03-1. The basis of the design includes identifying existing constraints (emergency power, electrical utility service, existing force main size, lagoon capacity, and excess flow treatment) for consideration in selecting pumps to meet existing and future design conditions. Although this study does not address any of the deficient conditions, it does allow for a flexible approach moving forward. Implementing Phase 1 improvements will replace the existing failing pumps and start to address excess flow capacity. Consideration can be given during final design to address existing DPF and DMF as well as future DPF. Phase 2 improvements will address future DMF considerations; however, those need to be evaluated further in connection with collection system improvements and treatment plant considerations.

	Phase 1 ^A	Phase 2 ^B
Type	Vertical Turbine	Vertical Turbine
Number	2	4
Capacity, Each (mgd)	13	13
Capacity, Firm (mgd)	23.8	50.0
Motor Size, Each (hp)	125	125
Drives	VFD (1)	VFD (2)

^A Phase 1 improvements do not include improvements to the existing emergency generator and currently do not include emergency power.

^B Phase 2 improvements require improvements to the incoming plant power switch gear, larger or parallel force main, and do not account for improvements in collection system I/I reduction.

Table 4.03-1 Excess Flow Pump(s) Design Criteria

B. Excess Flow Channel

The existing excess flow channel, which receives the 24-inch force main discharge from the Excess Flow Pumping Station and conveys it to the storage lagoon, was reviewed with this analysis. The existing channel is a concrete trapezoidal channel. The existing concrete channel has a total depth of 3 feet according to the WWTP record drawings. The flow capacity of the trapezoidal channel was calculated using Manning’s Formula based on the existing channel geometry at different flow depths and channel roughness values (n-values). Table 4.03-2 shows the calculated flow capacity at the different depths and roughness values compared to excess DPF and DMF values. Based on this analysis, it appears the channel has enough flow capacity to convey existing DMF and future DPF conditions with some freeboard left in the channel. The calculations indicate there would be approximately 6 to 9 inches of freeboard at these flow conditions. As can be seen in Table 4.03-1, the channel has calculated flow capacity equal to or greater than the future DMF to the lagoon at n-values

of 0.013 or less; however, the channel would be nearly full (within 2 inches or less on the top of the channel) under these flow conditions.

Because the calculations using Manning's Formula rely significantly on the channel roughness, as well as geometry, it would be prudent to do further testing and analysis on the existing channel to confirm its capacity. Based on this analysis and the values used in it, it would be recommended to provide additional depth to the sidewalls of the channel to provide some additional freeboard and capacity for future flow conditions. Additional freeboard and channel depth would likely be beneficial in any case to provide additional sidewall depth to allow for surface turbulence during flow conditions as well. Table 4.03-2 shows an additional 3 inches of sidewall depth could provide enough additional theoretical capacity for all flow conditions. This could be accomplished by casting concrete curb extensions along the top edges of the channel. If this is done, it would be recommended to add 6 inches or more of wall height with a concrete curb type of extension along the length of the channel on each side to provide some additional freeboard and containment capacity. This type of modification could be done in a phased approach with other excess flow modifications if desired. Design of these channel modifications would benefit from some field-testing of the channel with actual measurements and flow conditions. Field-testing may yield corrections to the theoretical calculations that could change outcomes.

Table 4.03-2 Excess Flow Channel Flow Capacity Calculations (Based on Manning's Formula)

Flow Depth (d) (ft)	n-value	Area (A) (ft ²)	Hydraulic Radius (R) (ft)	Slope (S) (ft/ft)	Flow (Q) (mgd)	Future DMF to Lagoon (mgd)	Existing DMF to Lagoon (mgd)	Future DPF to Lagoon (mgd)
2.00	0.012	8.00	1.04	0.001	20.90	42.12	25.10	21.67
2.25	0.012	9.56	1.14	0.001	26.53	42.12	25.10	21.67
2.50	0.012	11.25	1.24	0.001	32.96	42.12	25.10	21.67
2.75	0.012	13.06	1.34	0.001	40.21	42.12	25.10	21.67
2.85	0.012	13.82	1.37	0.001	43.35	42.12	25.10	21.67
2.95	0.012	14.60	1.41	0.001	46.63	42.12	25.10	21.67
3.00	0.012	15.00	1.43	0.001	48.33	42.12	25.10	21.67
3.25	0.012	17.06	1.52	0.001	57.35	42.12	25.10	21.67
2.00	0.013	8.00	1.04	0.001	19.30	42.12	25.10	21.67
2.25	0.013	9.56	1.14	0.001	24.49	42.12	25.10	21.67
2.50	0.013	11.25	1.24	0.001	30.42	42.12	25.10	21.67
2.75	0.013	13.06	1.34	0.001	37.12	42.12	25.10	21.67
2.85	0.013	13.82	1.37	0.001	40.02	42.12	25.10	21.67
2.95	0.013	14.60	1.41	0.001	43.05	42.12	25.10	21.67
3.00	0.013	15.00	1.43	0.001	44.61	42.12	25.10	21.67
3.25	0.013	17.06	1.52	0.001	52.94	42.12	25.10	21.67
2.00	0.014	8.00	1.04	0.001	17.92	42.12	25.10	21.67
2.25	0.014	9.56	1.14	0.001	22.74	42.12	25.10	21.67
2.50	0.014	11.25	1.24	0.001	28.25	42.12	25.10	21.67
2.75	0.014	13.06	1.34	0.001	34.46	42.12	25.10	21.67
2.85	0.014	13.82	1.37	0.001	37.16	42.12	25.10	21.67
2.95	0.014	14.60	1.41	0.001	39.97	42.12	25.10	21.67
3.00	0.014	15.00	1.43	0.001	41.43	42.12	25.10	21.67
3.25	0.014	17.06	1.52	0.001	49.16	42.12	25.10	21.67
2.00	0.015	8.00	1.04	0.001	16.72	42.12	25.10	21.67
2.25	0.015	9.56	1.14	0.001	21.23	42.12	25.10	21.67
2.50	0.015	11.25	1.24	0.001	26.36	42.12	25.10	21.67
2.75	0.015	13.06	1.34	0.001	32.17	42.12	25.10	21.67
2.85	0.015	13.82	1.37	0.001	34.68	42.12	25.10	21.67
2.95	0.015	14.60	1.41	0.001	37.31	42.12	25.10	21.67
3.00	0.015	15.00	1.43	0.001	38.66	42.12	25.10	21.67
3.25	0.015	17.06	1.52	0.001	45.88	42.12	25.10	21.67



PROJECT Washington, IL	BY BLS	DATE 3/27/2019	JOB NO. 1879.025
---------------------------	-----------	-------------------	---------------------

Excess Flow Channel to Lagoon (Existing)

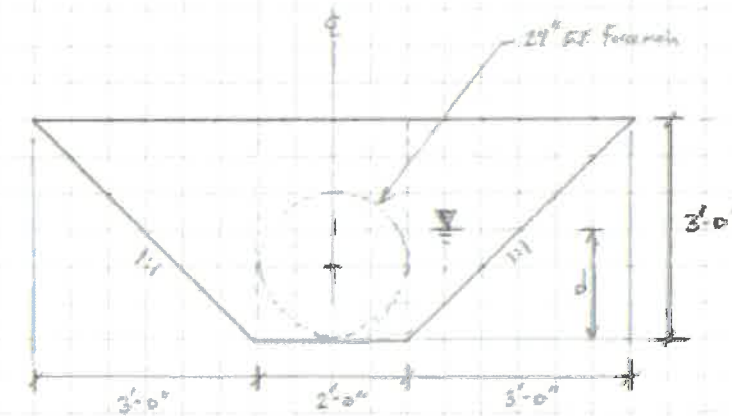

Existing Concrete Channel Cross Section (from 1987 Record Drawings - Attachment No. 1 Sheet 1 of 1)

$$A = \text{Area in ft}^2 = ((2)d + d^2) \text{ ft}^2 \quad \text{where } d = \text{depth of flow in ft}$$

$$R = \frac{A}{W} = \frac{\text{Area in ft}^2}{\text{Wetted Perimeter (ft)}} = \frac{(2)d + d^2}{2 + 2\sqrt{d^2 + d^2}} \text{ ft}$$

$$S = 0.10\% = \frac{0.10 \text{ ft}}{100 \text{ ft}} = 0.001 \text{ ft/ft} \quad \text{per record drawings}$$

$$\text{Manning's formula} \quad Q_{\text{MGD}} = \frac{0.963 A R^{2/3} S^{1/2}}{n} = \frac{0.963 ((2)d + d^2) \left[\frac{(2)d + d^2}{2 + 2\sqrt{d^2 + d^2}} \right]^{2/3} (0.001)^{1/2}}{n}$$

C. Excess Flow Storage Lagoon

The existing excess flow storage lagoon has a volume of approximately 16 million gallons according to the WWTP record drawings. The retention time of the lagoon was calculated at various future or excess flow conditions as shown in Table 4.03-3. This assumes the forward flow to the WWTP is limited to the WWTP forward flow capacity of 7.48 mgd and the excess flow is conveyed to the lagoon. The calculated retention time assumes the flow event starts with an empty lagoon to fill the entire volume at the given flow. Resultant retention times are shown in Table 4.03-3.

Flow Condition ¹	Total Flow to WWTP ¹ (mgd)	Forward Flow to WWTP ⁴ (mgd)	Excess Flow to Lagoon (mgd)	Basin Volume ² (million gallons)	Lagoon Retention Time ³	
					(days)	(hours)
Existing DPF	12.12	7.48	4.64	16	3.45	82.76
Existing DMF	32.58	7.48	25.10	16	0.64	15.30
Total Future DPF	29.15	7.48	21.67	16	0.74	17.72
Total Future DMF	49.60	7.48	42.12	16	0.38	9.12

Notes:

- ¹ Flow Conditions and Total Flow to WWTP obtained from Table 3.02-1 of Preliminary Engineering Study for the Farm Creek Trunk Sewer.
- ² Basin Volume obtained from Sewage Treatment Plant No. 2–Phase 2A Improvements (Contract 1-2015) Record Drawings.
- ³ Lagoon Retention Time assumes lagoon is empty at start of event and represents approximate retention time prior to overflow at constant flow rate.
- ⁴ 7.48 mgd is the current forward flow capacity of the WWTP (influent pumping capacity). Forward flow capacity and influent pumping capacity may be increased with future facility planning and expansion. Refer to Section 4.02 for additional information.

Table 4.03-3 Excess Flow Basin Retention Time (At Various Flows)

After the lagoon is full, the excess flow begins flowing out through the lagoon effluent structure to the existing Chlorine Contact Tank if the excess flow event lasts longer than the lagoon retention time.

D. Excess Flow Treatment

The existing excess flow treatment facilities consist of a chlorine contact tank and gaseous chlorination equipment. The original system was installed when the WWTP was first constructed and recently modified because of tornado damage. During those upgrades, the system was converted from 1-ton to 150-pound cylinders and storage is kept below the United States Environmental Protection Agency (USEPA) risk management program threshold of 2,500 pounds. The design criteria for the system is summarized in Table 4.03-4.

Number of Basins	2
Number of Passes, EA	6
Size	5-foot 6-inch width by 5-foot diameter by 493-foot length
Length to Width Ratio	90:1
Volume (Gallons)	101,410
Hydraulic Detention Time	
Future DMF (42.12 mgd), minutes	3.5
Existing DMF (17.9 mgd), minutes	8.1

Table 4.03-4 Excess Flow Chlorine Contact Tanks (Existing)

The dosage rate to achieve the fecal coliform permit limitation for excess flows is not known. This dosage rate is predicated on the quality of the excess flow and is variable. Therefore, Strand cannot comment on the chlorine storage and feed rate abilities of the excess flow facilities.

Strand can comment on the retention time for the chlorine contact tank, which 15 minutes is typically provided for peak flows. In the case of Washington, the detention time calculated above in Table 4.03-3 is assuming that the excess flow basin is full and the DMF event is going through the WWTP. Typically, flows are stored and treated with the forward flow when possible or the outfall flow rate can be controlled from the lagoon to provide additional retention time.

The existing design criteria for the excess flow facilities (lagoon and chlorination facilities) is not well defined and beyond the scope of this report. Based on the permit information in Tables 4.03-5 and 4.03-6, flows in excess of 6.37 mgd can be bypassed to the lagoon and subsequent excess flow chlorination facilities. Determining the amount of storage and chlorination desired and for what flow rate still needs to be determined. The performance values identified in Table 4.03-3 are based on no change in the existing infrastructure. This area of the WWTP requires further study and should be evaluated in the next facilities plan.

Parameter	Excess Flow Outfall A01				Sample Type
	Monthly Average	Weekly Average	Daily Maximum	Sample Frequency	
Total Flow (MG)					Continuous
Fecal Coliform			<400 per 100 mL	Daily when discharging	Grab
BOD ₅		Monitor only			
Suspended Solids		Monitor only			
Ammonia Nitrogen (as N)		Monitor only			
Total Phosphorus (as P)		Monitor only			
Chlorine Residual					

Notes: NPDES Permit No. IL0042412
 BOD₅=five-day biochemical oxygen demand

Table 4.03-5 Effluent Limitations from Excess Flow Outfall A01 for Flows Greater than DMF (6.37 mgd)

Parameter	Combined Discharge from Outfalls A01 and B01				Sample Type
	Monthly Average	Weekly Average	Daily Maximum	Sample Frequency	
Total Flow (MG)	30	45		Daily when A01 is discharging	Grab
Fecal Coliform	30	45			
BOD ₅					
Suspended Solids					
Chlorine Residual			0.75		
Ammonia Nitrogen (as N)		Monitor Only		Daily when Discharging	
Total Phosphorus (as P)		Monitor Only			
Dissolved Oxygen		Monitor Only			

NPDES Permit No. IL0042412

Table 4.03-6 Effluent Limitations from Excess Flow Outfall A01 and B01 for Flows Greater than DMF (6.37 mgd)

SECTION 5
OPINION OF PROBABLE CONSTRUCTION COST

5.01 ASSUMPTIONS

Opinions of probable construction cost were developed for Alternate Route A, Alternate Route B, and the new proposed influent pumping station.

5.02 OPINION OF PROBABLE CONSTRUCTION COST (OPCC)

Table 5.02-1 provides an OPCC for Alternate Route A.

Table 5.02-2 provides an OPCC for Alternate Route B.

Table 5.02-3 provides an OPCC for the pumping station improvements necessary to receive the lower interceptor elevation and provide for the projected flows. Note the OPCC includes costs for new VFDs for the submersible pumps to replace the existing VFDs. As previously noted, it appears likely that the existing VFDs would be able to be reused with some modifications; however, this should be more closely reviewed to confirm feasibility. If further design review confirms the existing VFDs could be reused, the cost of the VFDs would reduce the overall cost accordingly.

As discussed in Section 4.02, the influent pumping station preliminary design includes a four-pump station with provisions to expand to a six-pump station in the future. In the preliminary design, the wet well and valve vault would be sized to accommodate this general type of expansion. Further evaluation during facility planning and design may affect the size and cost of the pumping station, depending on the final design criteria determined.

Table 5.02-4 provides an OPCC to change out the existing excess flow pumping equipment. This OPCC does not include costs to modify the existing generator or the existing electrical service. Those cost would need to be further evaluated and are outside of the scope of this report because it involves looking at the facility holistically. Additionally, this OPCC does not include costs to improve the excess flow chlorination facilities.

Table 5.02-1 OPCC Alternate Route A

PRELIMINARY ENGINEERING OPCC		Preliminary Sewer Route A		
Description	Units	Engineer's Estimated Quantity	Opinion of Probable Unit Cost	Engineer's Opinion of Probable Cost
Sanitary sewer, 48-in	linear feet (LF)	10,603	\$350	\$3,711,050
Sanitary sewer, 8-in	LF	90	\$80	\$7,200
Sanitary sewer, 12-in	LF	80	\$110	\$8,800
Sanitary sewer, 15-in	LF	120	\$120	\$14,400
Protect existing sanitary sewer at crossing	each (EA)	12	\$4,000	\$48,000
Abandonment of existing sanitary manhole	EA	39	\$2,000	\$78,000
Sanitary manhole, type a, 6-foot (ft) diameter (dia), less than 20 ft deep	EA	12	\$9,000	\$108,000
Sanitary manhole, type a, 6-ft dia, 20 ft to 25 ft deep	EA	5	\$12,000	\$60,000
Sanitary manhole, type a, 6-ft dia, 25 ft to 30 ft deep	EA	2	\$15,000	\$30,000
Sanitary manhole, type a, 6-ft dia, 30 ft to 35 ft deep	EA	-	\$18,000	\$0
Sanitary manhole, type a, 6-ft dia, 35 ft to 40 ft deep	EA	-	\$21,000	\$0
Sanitary manhole, type a, 6-ft dia constructed on existing sewer pipe	EA	3	\$12,000	\$36,000
Sanitary manhole, type a, 8-ft dia, less than 20 ft deep	EA	10	\$18,000	\$180,000
Sanitary manhole, type a, 8-ft dia, 20 ft to 25 ft deep	EA	3	\$22,000	\$66,000
Sanitary manhole, type a, 8-ft dia, 25 ft to 30 ft deep	EA	-	\$26,000	\$0
Special structures	EA	2	\$20,000	\$40,000
Outside drop manhole connection, 24-in	EA	1	\$8,000	\$8,000
Trenchless construction, 24-in sanitary sewer with 36-in steel casing pipe	LF	-	\$600	\$0
Trenchless construction, 48-in sanitary sewer with 60-in steel casing pipe	LF	1,463	\$800	\$1,170,400
Work shafts for trenchless construction, 24-in sanitary sewer	EA	-	\$8,000	\$0
Work shafts for trenchless construction, 48-in sanitary sewer	EA	12	\$12,000	\$144,000
Foundation material	cubic yard (CY)	471	\$52	\$24,505
Select granular backfill-CA-7	CY	-	\$30	\$0
Restoration-seed	square yards	70,687	\$2	\$141,373
Silt fence/erosion controls	FT	8,482	\$4	\$33,930
Stabilized construction entrance	EA	2	\$6,000	\$12,000
Tree removal (over 6 units dia)	IN	8,482	\$12	\$101,789
Construction Subtotal				\$6,023,446
Mobilization	2 percent			\$120,469
Legal and Land Acquisition	5 percent			\$301,172
Contingencies	25 percent			\$1,505,862
Total OPCC				\$7,950,949.31

Table 5.02-2 OPCC Alternate Route B

PRELIMINARY ENGINEERING OPCC		Preliminary Sewer Route B		
Description	Units	Engineer's Estimated Quantity	Opinion of Probable Unit Cost	Engineer's Opinion of Probable Cost
Sanitary sewer, 48-in	LF	9,385	\$350	\$3,284,750
Sanitary sewer, 8-in	LF	520	\$80	\$41,600
Sanitary sewer, 18-in	LF	220	\$140	\$30,800
Protect existing sanitary sewer at crossing	EA	3	\$4,000	\$12,000
Abandonment of existing sanitary manholes	EA	39	\$2,000	\$78,000
Sanitary manhole, type a, 6-ft dia, less than 20-ft deep	EA	14	\$9,000	\$126,000
Sanitary manhole, type a, 6-ft dia, 20 ft to 25 ft deep	EA	3	\$12,000	\$36,000
Sanitary manhole, type a, 6-ft dia, 25 ft to 30 ft deep	EA	1	\$15,000	\$15,000
Sanitary manhole, type a, 6-ft dia, 30 ft to 35 ft deep	EA	1	\$18,000	\$18,000
Sanitary manhole, type a, 6-ft dia, 35 ft to 40 ft deep	EA	1	\$21,000	\$21,000
Sanitary manhole, type a, 6-ft dia constructed on existing sewer pipe	EA	3	\$12,000	\$36,000
Sanitary manhole, type a, 8-ft dia, less than 20 ft deep	EA	5	\$18,000	\$90,000
Sanitary manhole, type a, 8-ft dia, 20 ft to 25 ft deep	EA	3	\$22,000	\$66,000
Sanitary manhole, type a, 8-ft dia, 25 ft to 30 ft deep	EA	-	\$26,000	\$0
Special structures	EA	2	\$20,000	\$40,000
Outside drop manhole connection, 24-in	EA	1	\$8,000	\$8,000
Trenchless construction, 8-in sanitary sewer with 20-in steel casing pipe	LF	140	\$400	\$56,000
Trenchless construction, 18-in sanitary sewer with 30-in steel casing pipe	LF	280	\$450	\$126,000
Trenchless construction, 48-in sanitary sewer with 60-in steel casing pipe	LF	1,740	\$800	\$1,392,000
Work shafts for trenchless construction, 24-in sanitary sewer	EA	-	\$8,000	\$0
Work shafts for trenchless construction, 48-in sanitary sewer	EA	14	\$12,000	\$168,000
New 12-in inside existing 30-in	LF	12	\$1,250	\$15,000
Foundation material	CY	417	\$52	\$21,690
Select granular backfill-CA-7	CY	-	\$30	\$0
Restoration-seed	SY	62,567	\$2	\$125,133
Silt fence/erosion controls	FT	7,508	\$4	\$30,032
Stabilized construction entrance	EA		\$6,000	\$0
Tree removal (over 6 units dia)	IN	7,508	\$12	\$90,096
Construction Subtotal				\$5,927,101
Mobilization	2 percent			\$118,542
Legal and Land Acquisition	5 percent			\$296,355
Contingencies	25 percent			\$1,481,775
Total OPCC				\$7,823,773.47

Table 5.02-3 Submersible Pumping Station OPCC

Preliminary Engineering OPCC	Engineer's OPCC
Description	
Sitework	
Clearing and stripping topsoil	\$2,000
Pavement and sidewalk removal	\$15,000
Demolition	
Grit facilities	\$14,000
Shed	\$3,000
Sluice gate structure	\$7,000
Manhole s and buried piping	\$12,000
Existing influent pumping station (such as pumps and piping)	\$27,000
Electrical Demo (existing pumps, controls, and miscellaneous site)	\$16,000
Temporary bypass pumping and piping	\$50,000
Site dewatering	\$32,000
Erosion and sediment control	\$2,000
Excavation	\$67,000
Sheeting, shoring, and lagging	\$234,000
Allowance for unsuitable subgrade (beneath structures and roads)	\$25,000
MHs	\$35,000
Buried gravity sewer and excess flow piping	\$137,000
Buried 16-inch raw wastewater force Main	\$25,000
Buried NPW piping and yard hydrant	\$2,000
Crushed aggregate basecourse (for roads and paved areas)	\$37,000
HMA pavement (for roads and paved areas)	\$34,000
Sidewalks	\$6,000
Topsoil, landscaping, and restoration	\$4,000
Site electrical	\$41,000
	\$827,000
	Subtotal
New Submersible Pumping Station	
Geotextiles	\$1,000
Crushed stone mat	\$7,000
Compacted fill and backfill	\$106,000
Reinforced concrete	\$493,000
Aluminum ladder and metal fabrications	\$4,000
Sharp-crested weir and accessories (excess flow)	\$1,000
Aluminum access doors	\$16,000
Painting	\$21,000
Sluice gates	\$35,000
Submersible pumps and accessories	\$250,000
Interior Piping	
Piping and valves in new submersible pumping station	\$234,000
New piping in existing control building	\$30,000
Electrical	
Float switches	\$2,000
Level transducers	\$3,000
Conduit and wiring	\$9,000
Local disconnect switches, receptacles, etc.	\$9,000
VFD feeder breakers	\$3,000
VFDs (for new submersible pumps)	\$41,000
Electrical mounting structures at pumping station	\$5,000
SCADA integration	\$20,000
	Subtotal
	\$1,290,000
	Subtotal (Sitework and Pumping Station)
	\$2,117,000
General Conditions, bonds, and insurance (8 percent)	\$169,000
Contingencies (25 percent)	\$529,000
	Total OPCC
	\$2,815,000

Note: Costs are in first quarter 2019 dollars.

Construction Item	Cost
Equipment and Structures	
Pumps (two)	\$344,000
Motor control, instrumentation and controls	\$100,000
Wet well modifications	\$100,000
Subtotal equipment and structures	\$444,000
Piping and mechanical (20 percent)	\$89,000
Electrical (20 percent)	\$31,000
Sitework (7 percent)	\$31,000
Subtotal Base Construction	\$653,000
Contractor General Conditions (12 percent)	\$78,000
OPCC	\$731,000
Contingencies (20 percent)	\$146,000
Technical Services (15 percent)	\$110,000
Opinion of Total Project Cost	\$987,000

Note: Costs are in first quarter 2019 dollars. The costs reflect the installation of two new pumps and a motor control. It does not include costs for two additional pumps to provide capacity for future DMF.

Table 5.02-4 Excess Flow Pumping Equipment OPCC

**SECTION 6
RECOMMENDATIONS**

6.01 CONCLUSIONS

The City has documented numerous concerns with the existing 50-year-old Farm Creek Trunk Sewer including:

- Operational problems because of its proximity to Farm Creek.
- Instability and erosion of Farm Creek leading to exposed sewer pipe in several locations.
- Excess flow conditions in the sewer during wet weather and high creek flow conditions.
- Anticipated continued growth and development potentially exceeding trunk sewer capacity.

The City has also been mandated by the IEPA to decommission existing STP 1, which will result in additional burden on the trunk sewer by flow that was previously sent to STP 1.

Flow monitoring of the City's sanitary sewer system, presented in Section 2, confirmed current average dry weather flows from the sanitary sewers and the trunk sewer itself are generally equal or less than what would theoretically be expected in the system and that the Farm Creek Trunk Sewer is currently capable of handling these flows. However, flow monitoring also indicated the City's sanitary sewer system and the trunk sewer are highly susceptible to wet weather conditions. In particular, wet weather conditions flow metered on July 6 and August 30, 2016, resulted in sewer system flows far greater than would be expected and exceeding the trunk sewer full-pipe flow capacity posing the potential for significant system backups and overflows.

An assessment of potential future full build-out conditions for the City and the projected future sanitary sewer flows is presented in Section 3 and it appears the existing Farm Creek Trunk Sewer does not have sufficient capacity to convey ADFs under future full build-out conditions. The projected future flows were used to determine the design capacity needed for a new Farm Creek Trunk Sewer. From this evaluation, a minimum 42-inch nominal inside diameter pipe was identified to provide sufficient full pipe flow capacity for future flow conditions.

Section 3 further evaluated two potential routes for a new Farm Creek Trunk Sewer, a northern route and a southern route. The characteristics of the northern route (Route A) included the following:

- Generally north of the railroad following a similar route to the existing sewer along Farm Creek.
- Several conflicts with the existing trunk sewer will require special construction operations.
- Relatively shallow pipe depths because of proximity to the low creek valley but does exceed 20 feet in a few locations and reaches 30 feet in one location.
- Mostly in Farm Creek floodplain and crosses the creek no less than 15 times.
- Crosses seven private properties and crosses the railroad twice.
- Allows for the easiest connection of existing tributary sewers.
- Susceptible to similar erosion and exposure near the creek.
- Susceptible to excess flow impacts from the creek and high groundwater.
- Requires significant environmental permitting and construction requirements because of proximity to the creek.
- Poses operational concerns with limited maintenance access to manholes near the creek.
- Longer length of pipe and has more manholes than Route B.

The characteristics of the southern route (Route B) included the following:

- South of the railroad, mostly avoiding Farm Creek, and no conflicts with the existing trunk sewer.
- Higher ground elevations result in deeper excavations generally between 10 and 20 feet with a few stretches between 25 to 30 feet, and four locations exceeding 50 feet probably requiring trenchless construction operations.
- Mostly outside of Farm Creek floodplain with only two creek crossings.
- Crosses three private properties.
- Connection of existing tributary sewers requires two railroad crossings of local sewers connecting to the new trunk sewer.
- Minimizes susceptibility to creek erosion and exposure.
- Minimizes susceptibility to I/I from the creek and high groundwater.
- Minimizes environmental impacts and permitting.
- Provides accessibility to manholes for maintenance.
- Shorter length of pipe and less manholes than Route A.

A series of dynamic hydraulic models were used to evaluate the new trunk sewer as well as operational conditions at the existing influent pumping station, as presented in Section 3. The modeling indicated current peak dry weather flow conditions can potentially require all three raw sewage pumps to operate and wet weather conditions, like those experienced July 6 and August 30, 2016, require all the raw sewage and stormwater pumps to operate and still allows highwater levels to reach within 10 feet of top of the influent pumping station. The modeling further indicated the current influent pumping station will not have capacity to handle projected future ADF conditions, let alone the future wet weather flow conditions.

6.02 RECOMMENDATIONS

The following recommendations come from the conclusions of this report:

A. Excess Flow Removal Program

The City currently experiences excess wet weather flow conditions in its sewer system that potentially exceed the capacity of the local sewers, the Farm Creek Trunk Sewer, and the influent pumping station at STP 2. The City should perform a sanitary sewer evaluation study (SSES) to identify the sources I/I contributing excess flow to the system. Common sources of I/I include manhole defects, manhole flooding, pipe defects, and storm sewer cross connections. However, I/I can also come from private sources such as connected downspouts, foundation drains, and sump pumps from homes and businesses. An SSES study would prioritize areas of the City exhibiting the highest levels of excess flow and endeavor to identify potential sources through manhole inspections, smoke testing, dye testing, and sewer televising. The SSES study should also consider a private source investigation, which may include home inspections. The results of the SSES would define potential rehabilitation and removal methods to reduce excess flows in the system.

B. New Trunk Sewer

It is recommended the City begin pursuing funding, easement acquisition, design, and construction of a new trunk sewer to replace the existing Farm Creek Trunk Sewer as presented in Section 3. An SSES program will help the City reduce excess flows in the overall sanitary sewer system, but it is not anticipated to eliminate excess flow impacts to the existing Farm Creek Trunk Sewer. Farm Creek will continue to threaten the stability of the existing trunk sewer and poses continued I/I influence on the trunk sewer regardless of whether rehabilitation is performed. Additionally, the existing trunk sewer does not have capacity to convey projected future flow contributions

The new trunk sewer would be a minimum 42-inch nominal inside diameter pipe. It is further recommended the new trunk sewer follow the southern route (Route B), which provides separation from Farm Creek, accessibility for operation and maintenance, and lower estimated cost than the northern route.

C. New Influent Pumping station

It is recommended the City begin pursuing funding, design, and construction of a new influent pumping station to supplement the existing influent pumping station as presented in Section 4. The City currently experiences issues with the existing influent pumping station including problems with rags and clogging of the existing influent sewage pumps as well as capacity concerns during daily peaks and wet weather conditions. Additionally, the existing pumping station does not have capacity for future projected flows and the recommended new trunk sewer invert elevation at the station is approximately 3.25 feet lower than the station floor.

The new influent pumping station would have an immediate capacity of 7.48 mgd with four submersible pumps on VFDs installed in a new cast-in-place concrete structure located north of the West Aerobic Digester. Excess flow beyond 7.48 mgd would be bypassed to the existing influent pumping station and handled by the excess flow pumps and lagoon. The new influent pumping station would be designed to allow for capacity increases to handle future flows based on subsequent facility planning and expansion for the WWTP.

D. Next Steps

It is recommended the City consider the following next steps to advance the new trunk sewer and influent pumping station projects.

1. Funding

Construction of the new trunk sewer and influent pumping station is eligible for funding through the IEPA State Revolving Loan Fund program. Upon City's approval of this Preliminary Engineering Study, the findings and recommendations of this study should be modified and compiled into a Water Pollution Control Project Plan (Project Plan) in conformance with IEPA Project Plan requirements. Included in the Project Plan should be the City's financial arrangements to cover the annual debt repayment as well as operation and maintenance needs, a dedicated revenue source for loan repayment, and any change from current to proposed rate

structures. The City should also complete a Funding Nomination Form (FNF) and submit the Project Plan and FNF to the IEPA by January 31, 2020.

It is anticipated it will take IEPA 8 to 12 months to review and approve the Project Plan so the earliest the City would be eligible to receive funding would be fiscal year starting July 1, 2021. While the IEPA reviews the Project Plan, the City should proceed with easement acquisition and engineering design as discussed in the following.

2. Easement Acquisition and Engineering Design

It is understood that the City has started easement discussions with property owners based upon the southern route (Route B) included in Appendix B. The City should continue these discussions to obtain commitments for final easements. Completion of easement acquisition will be required as part of submitting a Water Pollution Control Loan (WPCLP) Application form to the IEPA. It is recommended the City complete land acquisition and submit the WPCLP Application by July 1, 2020 to best position the City for funding approval in January 2021.

Final engineering design should begin based upon Route B. Design would include such tasks as topographic survey of the desired route; wetland and natural area identification and delineation; development of engineering drawings and technical specifications; pursuit of project approvals from affected agencies at least including railroad, United States Army Corps of Engineers, Illinois Department of Natural Resources, and IEPA. Completing final engineering tasks will inform the IEPA that the City's project is ready for advertising and a strong candidate for funding.

3. Construction

Assuming the City will use IEPA loan funding for construction of the new trunk sewer and influent pumping station, the City will need to be included on IEPA's Intended Funding List (IFL). Inclusion on the IFL requires Project Plan approval from IEPA and submittal of the FNF and a WPCLP Application. These tasks need to be completed by January 31, 2021, for the City's project to be placed on the IEPA's IFL for funding starting July 1, 2021. It is not recommended the project be advertised for bidding until the project is confirmed to be on the IFL.

Assuming the City's project makes the IFL issued in 2021, the City would advertise the project by April 15, 2021, submit final bid documents for IEPA review, and obtain a final loan agreement from the IEPA.

It is anticipated construction of both the new trunk sewer and the new influent pumping station will take approximately 18 months.

Under the recommended schedule previously described, there is a chance the City could have its project considered for funding earlier in 2021 through IEPA's "bypass" process. It is recommended the City maintain communication with its IEPA project manager throughout 2020 to assess this opportunity.

APPENDIX A
ALTERNATE ROUTE A PLAN AND PROFILE DRAWINGS

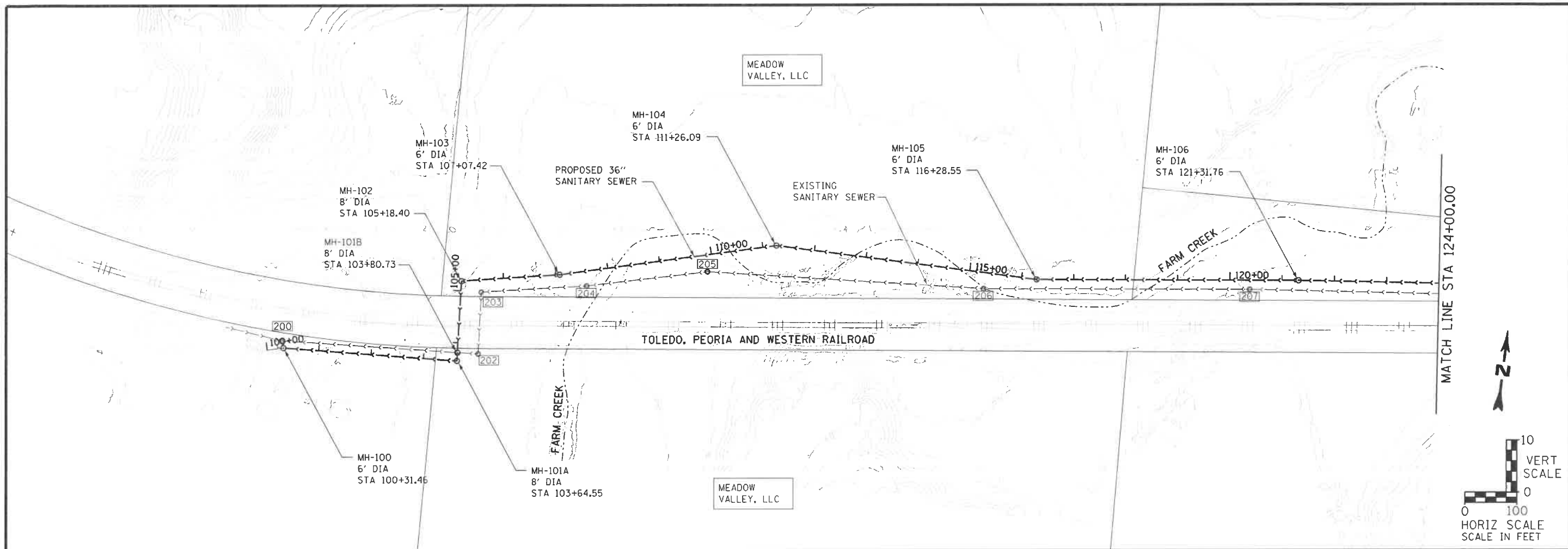

NO.	REVISIONS	DATE:

ALTERNATE A PLAN AND PROFILE
FARM CREEK TRUNK SEWER REPLACEMENT PROJECT
 CITY OF WASHINGTON
 TAZEWELL COUNTY, ILLINOIS

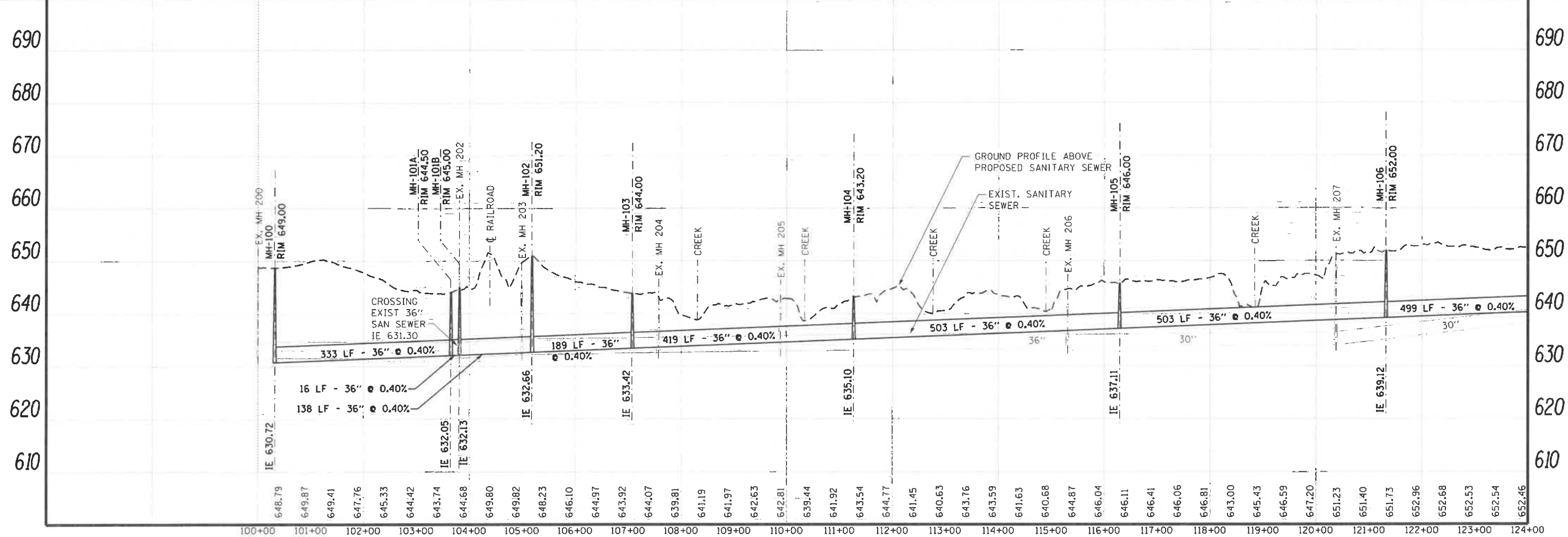

JOB NO.
1879.026
 PROJECT MGR.
AJS

 SHEET
A-1

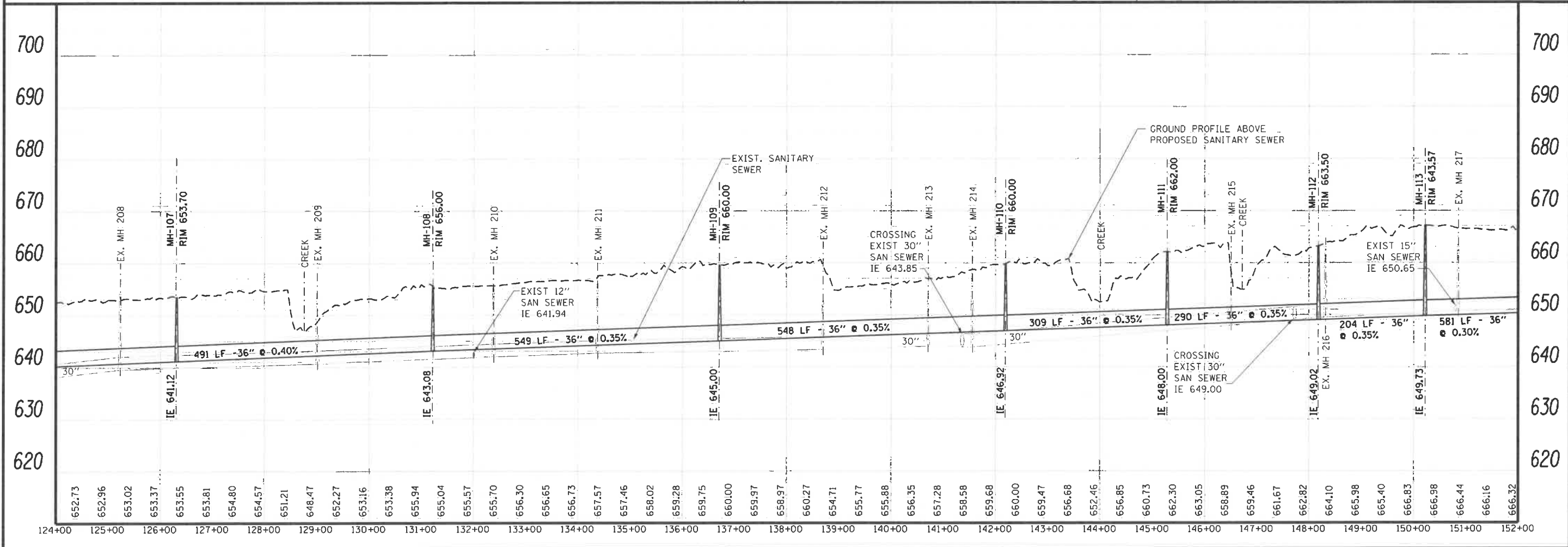
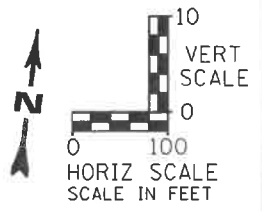
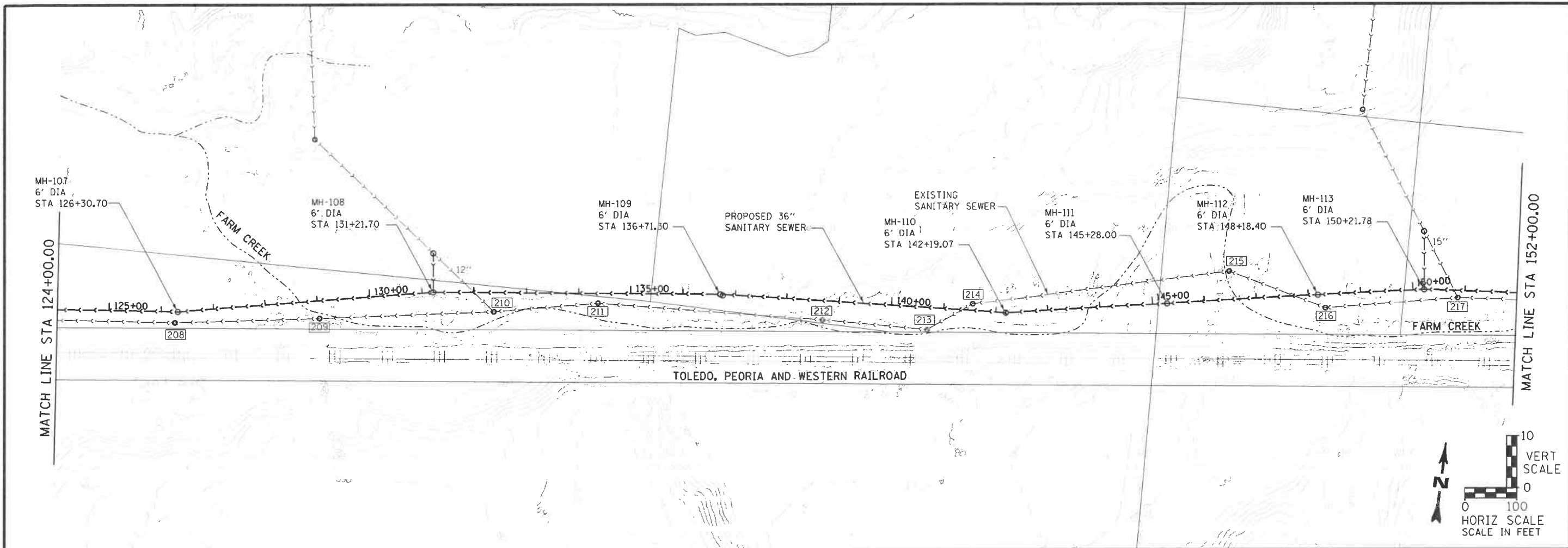

NO.	REVISIONS	DATE:

ALTERNATE A PLAN AND PROFILE
FARM CREEK TRUNK SEWER REPLACEMENT PROJECT
 CITY OF WASHINGTON
 TAZEWELL COUNTY, ILLINOIS

JOB NO.
1879.026
 PROJECT MGR.
AJS



SHEET
A-2

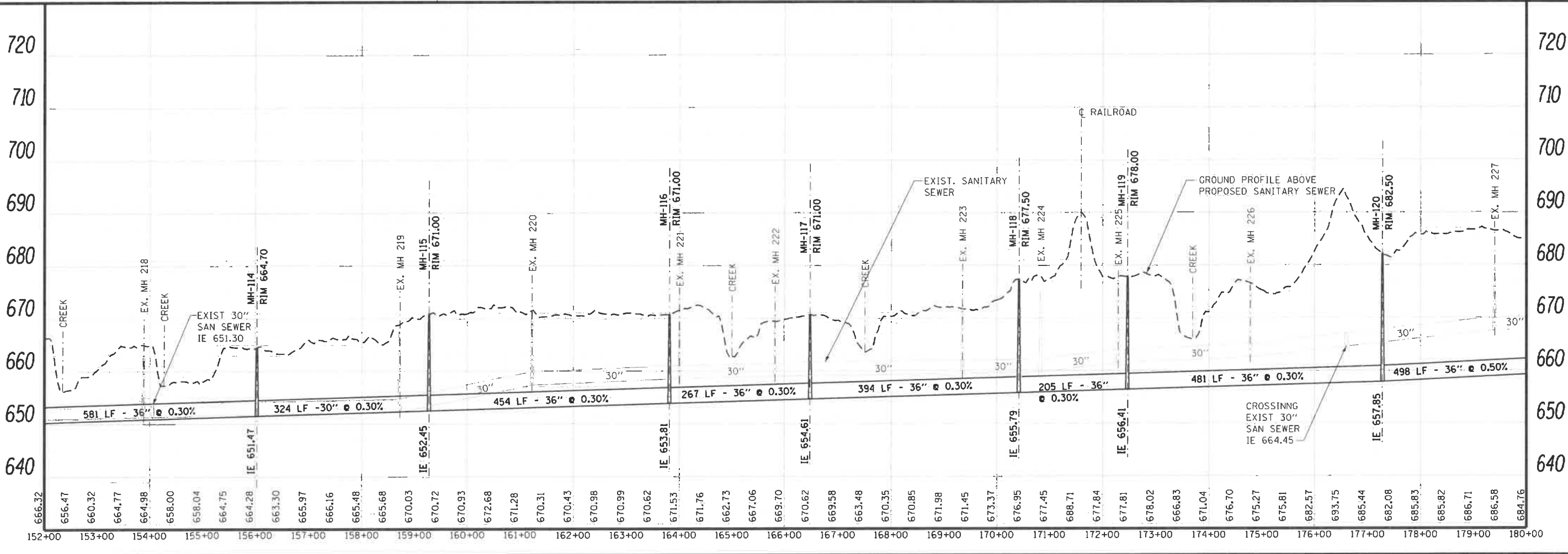
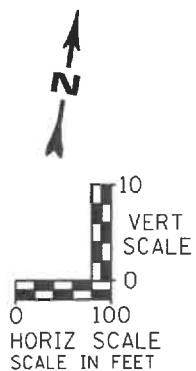
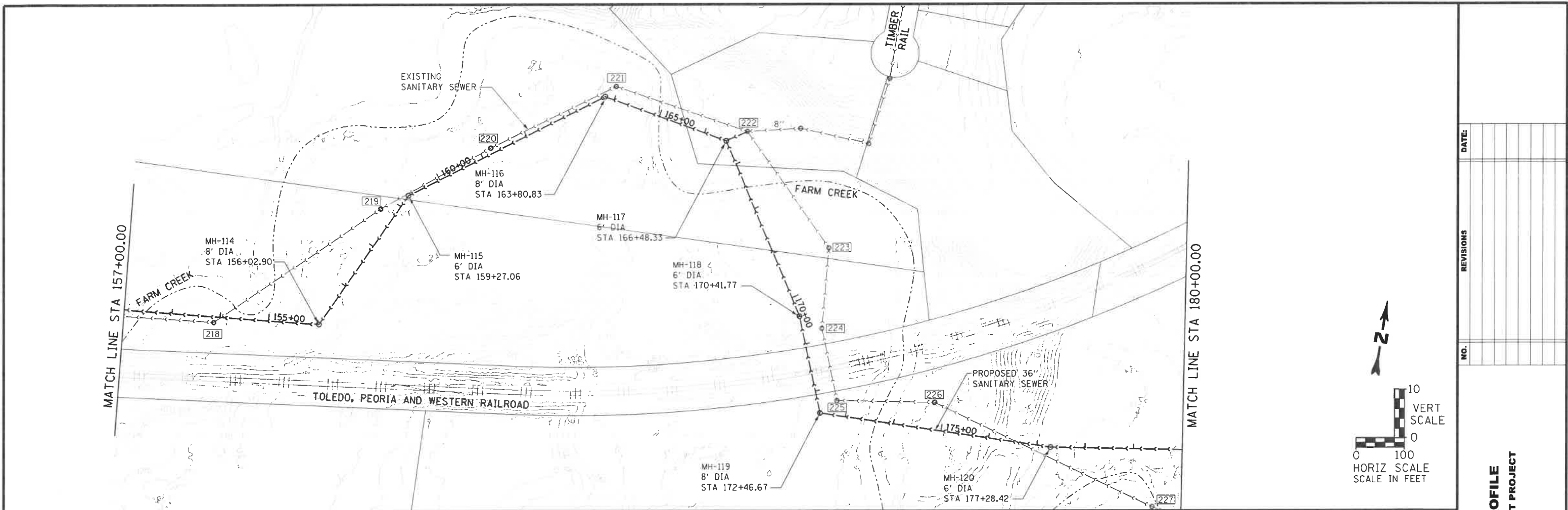

NO.	REVISIONS	DATE

ALTERNATE A PLAN AND PROFILE
FARM CREEK TRUNK SEWER REPLACEMENT PROJECT
 CITY OF WASHINGTON
 TAZEWELL COUNTY, ILLINOIS

JOB NO. 1879.026
 PROJECT MGR. AJS



SHEET A-3

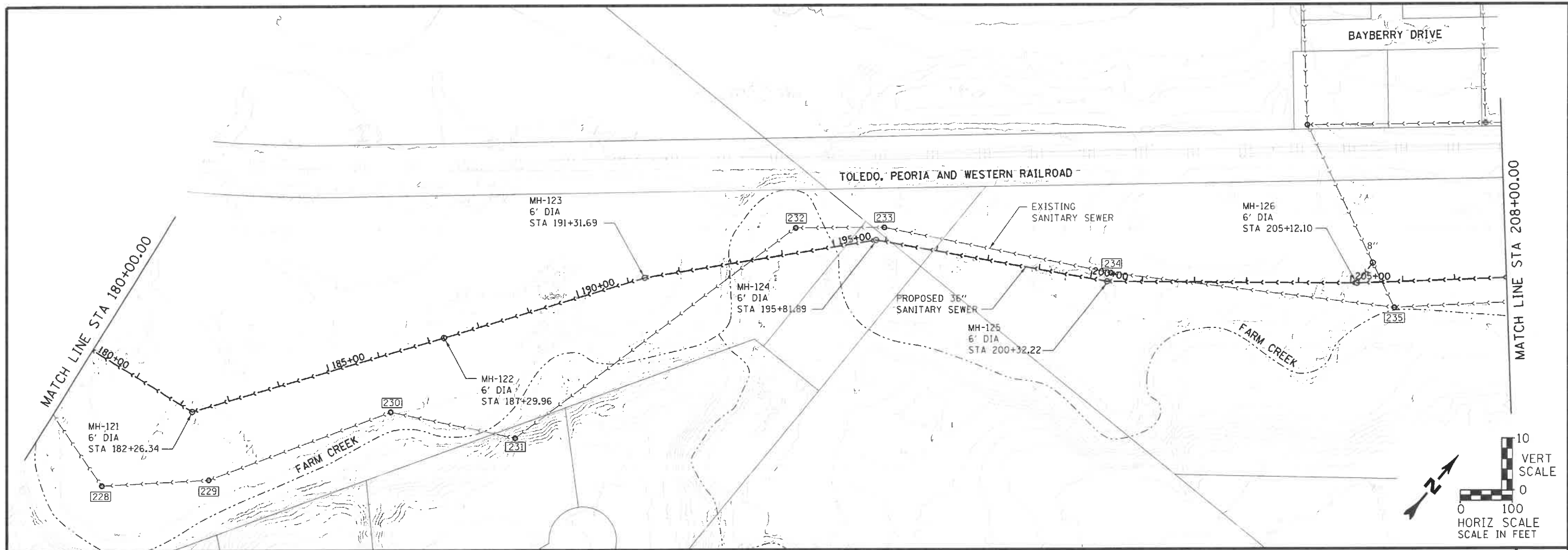

NO.	REVISIONS	DATE

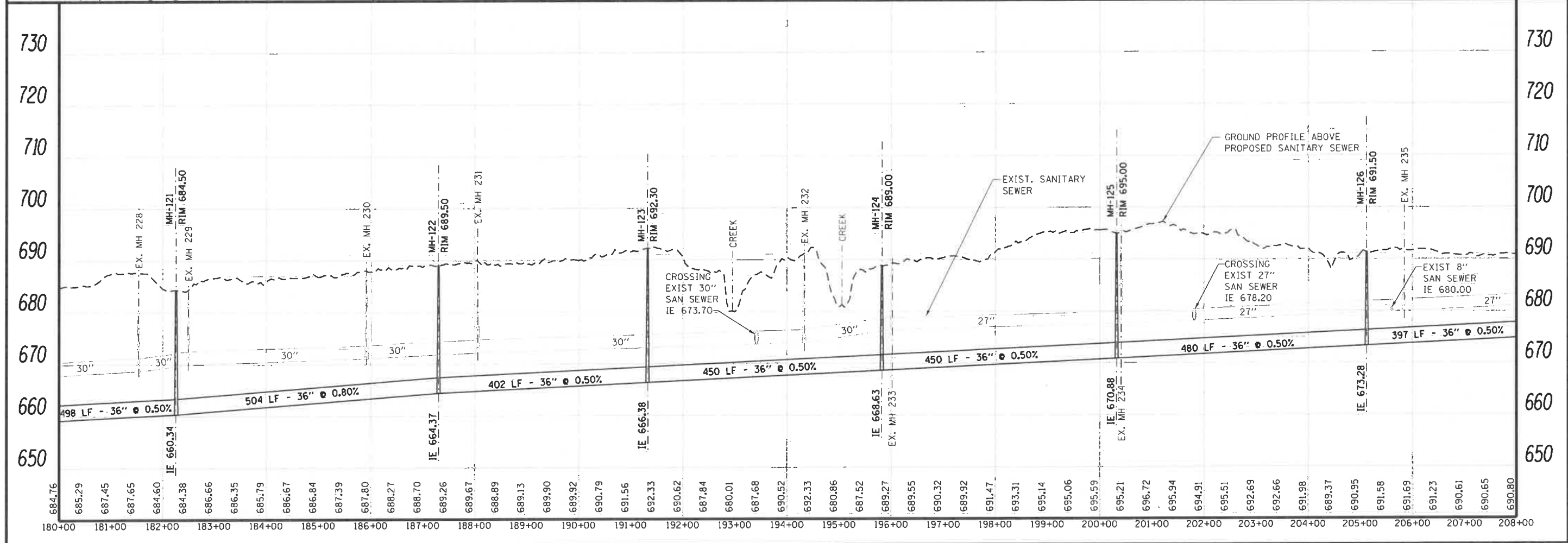
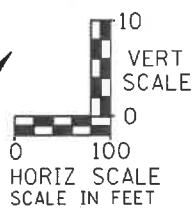

ALTERNATE A PLAN AND PROFILE
FARM CREEK TRUNK SEWER REPLACEMENT PROJECT
 CITY OF WASHINGTON
 TAZEWELL COUNTY, ILLINOIS

JOB NO.
1879.026
 PROJECT MGR.
AJS

 SHEET
A-4

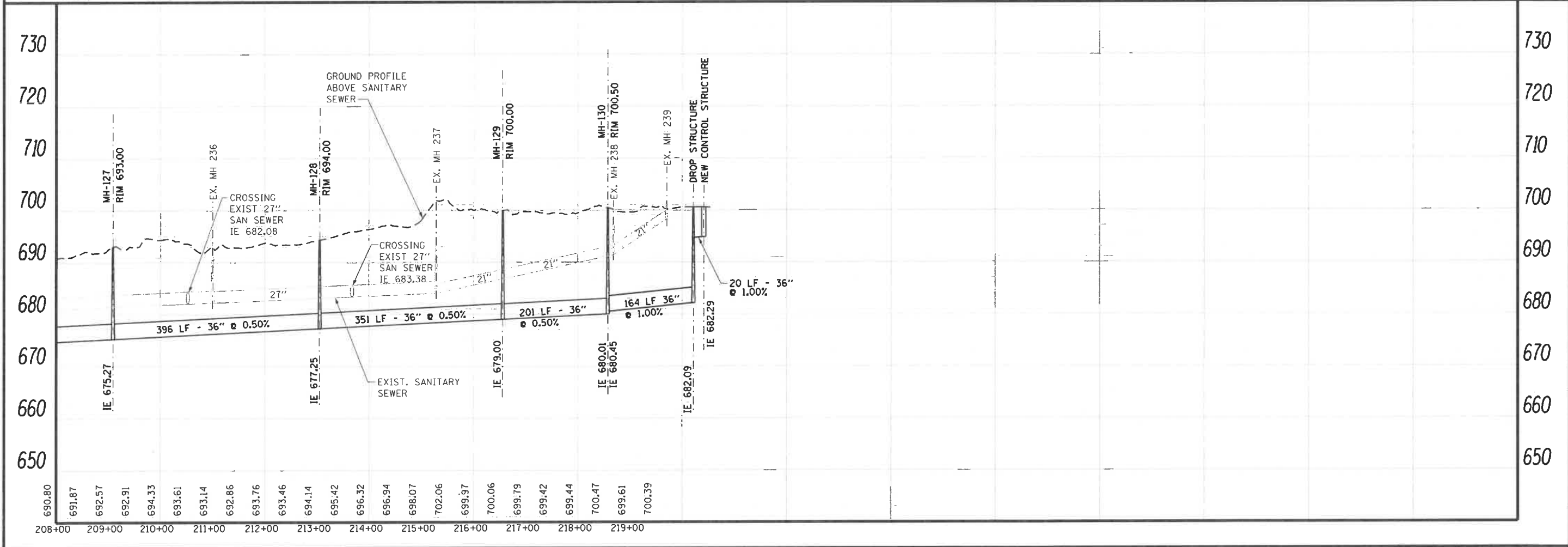
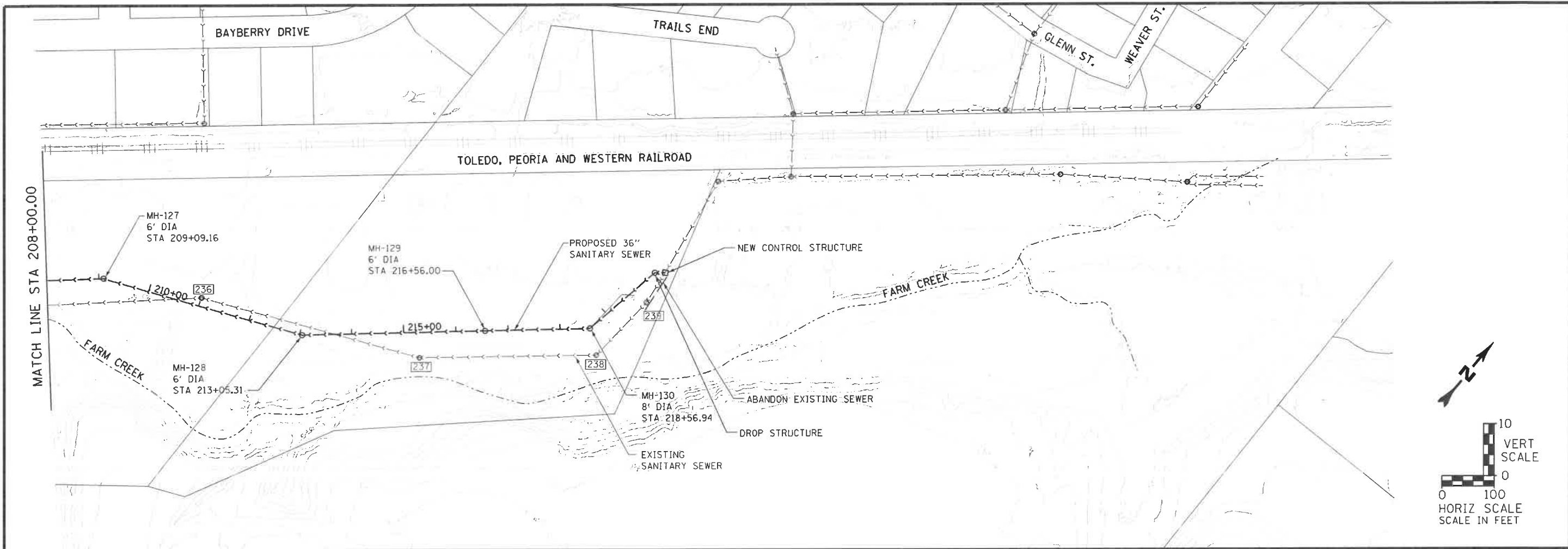

NO.	REVISIONS	DATE:

ALTERNATE A PLAN AND PROFILE
FARM CREEK TRUNK SEWER REPLACEMENT PROJECT
 CITY OF WASHINGTON
 TAZEWELL COUNTY, ILLINOIS

JOB NO.
1879.026
 PROJECT MGR.
AJS



SHEET
A-5

APPENDIX B
ALTERNATE ROUTE B PLAN AND PROFILE DRAWINGS

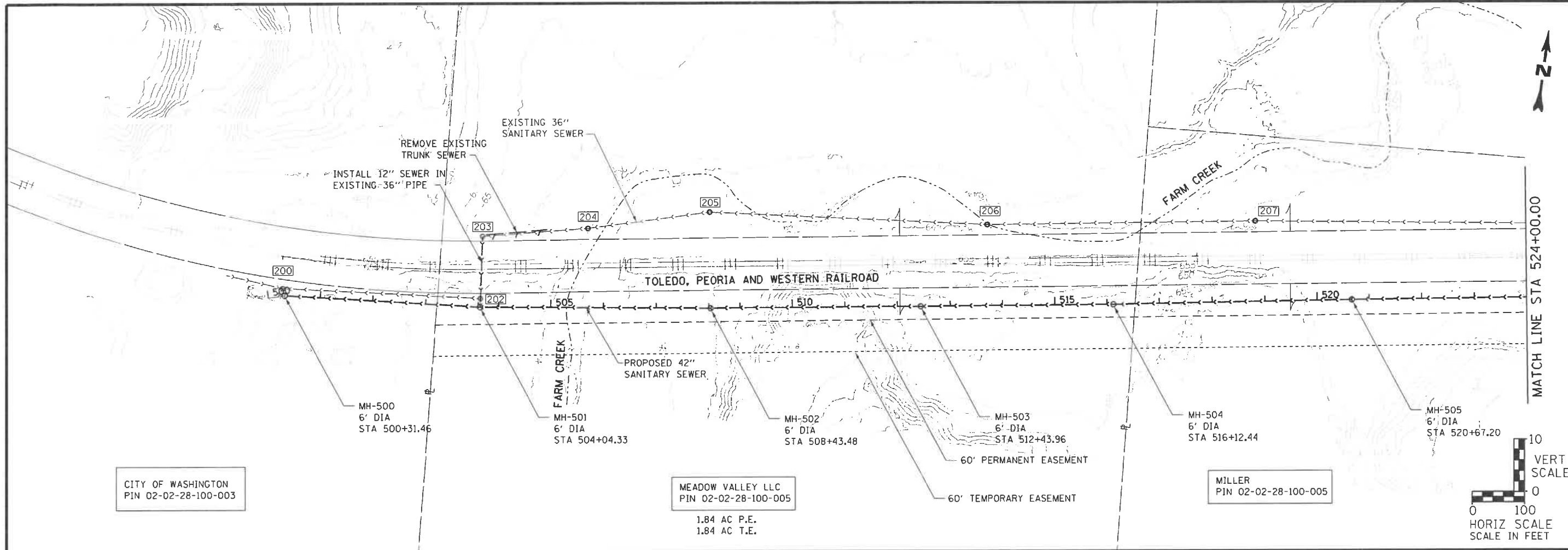

NO.	REVISIONS

ALTERNATE B PLAN AND PROFILE
FARM CREEK TRUNK SEWER REPLACEMENT PROJECT
 CITY OF WASHINGTON
 TAZEWELL COUNTY, ILLINOIS

JOB NO.
 1879.026
 PROJECT MGR.
 AJS
STRAND ASSOCIATES
 SHEET
B-1

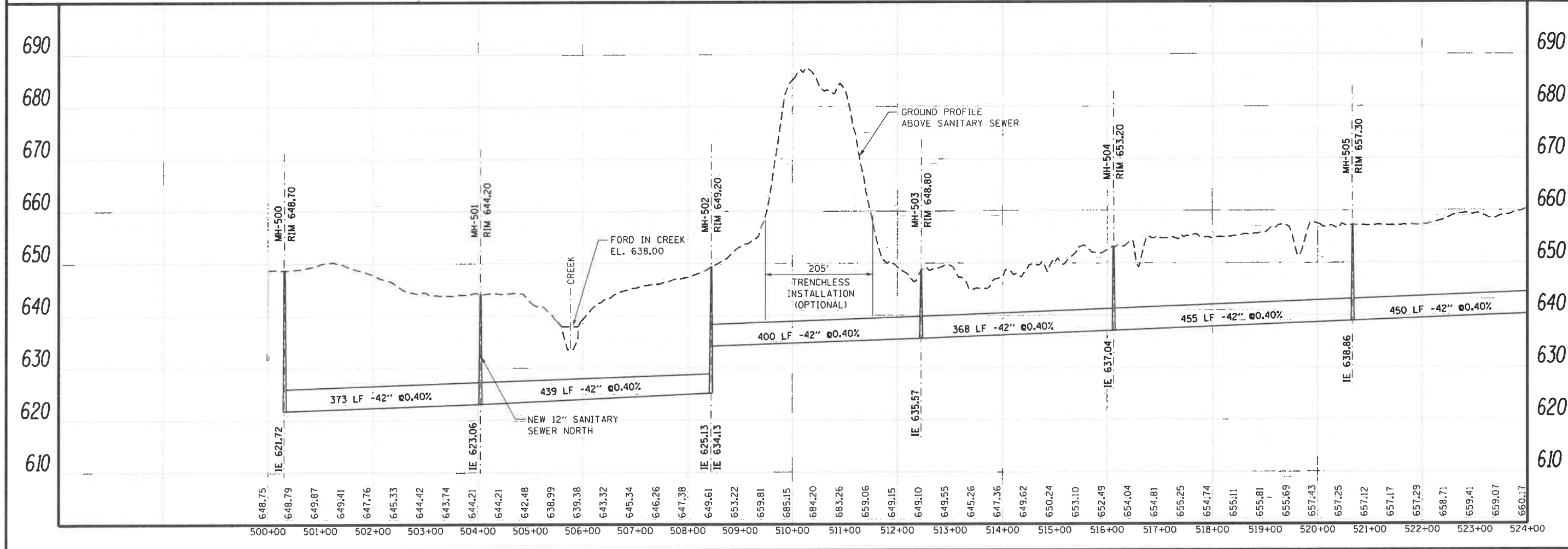

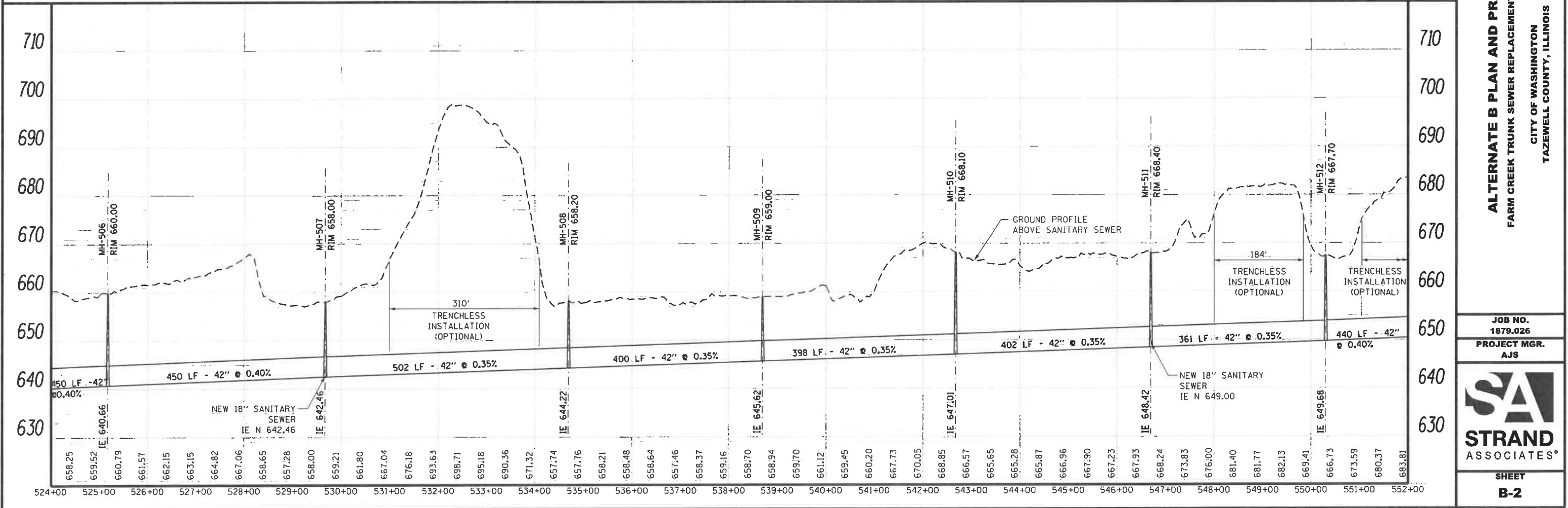
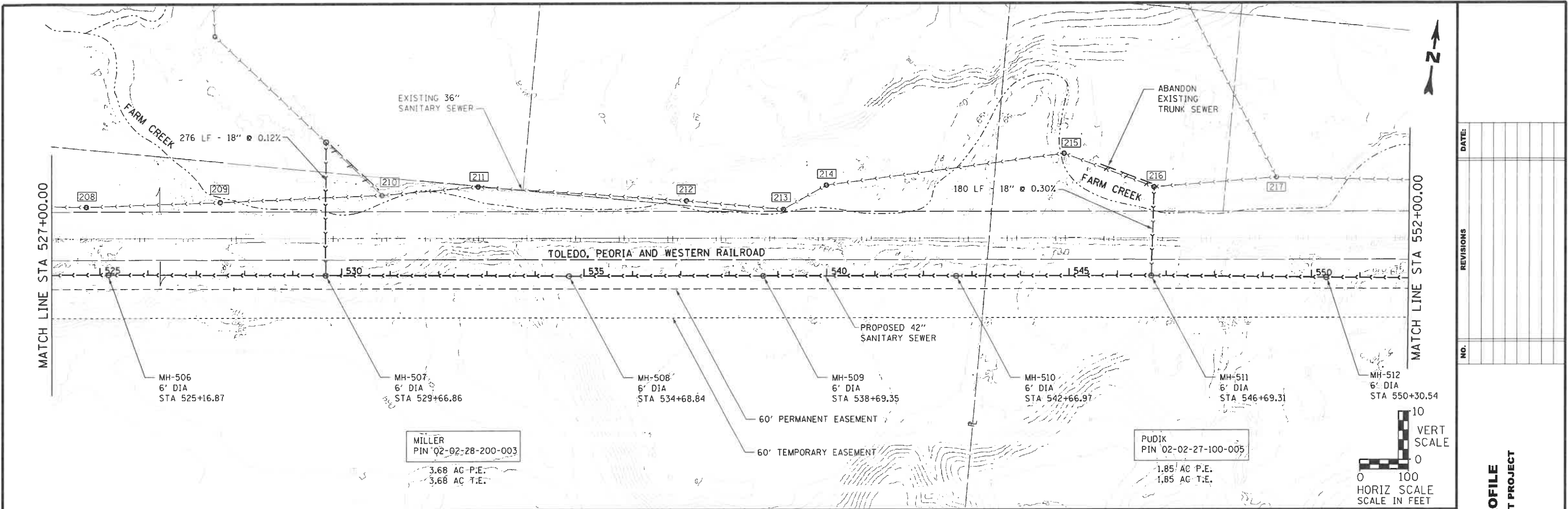

DATE: _____

REVISIONS

NO.

ALTERNATE B PLAN AND PROFILE
FARM CREEK TRUNK SEWER REPLACEMENT PROJECT
CITY OF WASHINGTON
TAZEWELL COUNTY, ILLINOIS

JOB NO.
1879.026

PROJECT MGR.
AJS



SHEET
B-2

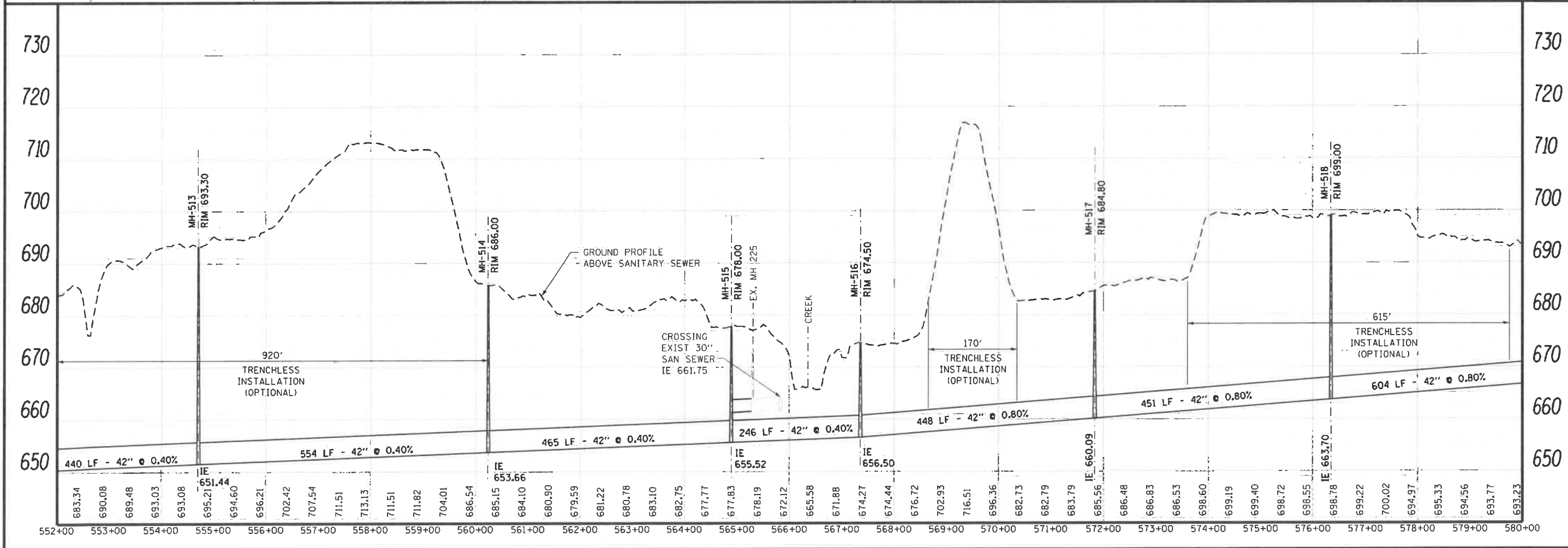
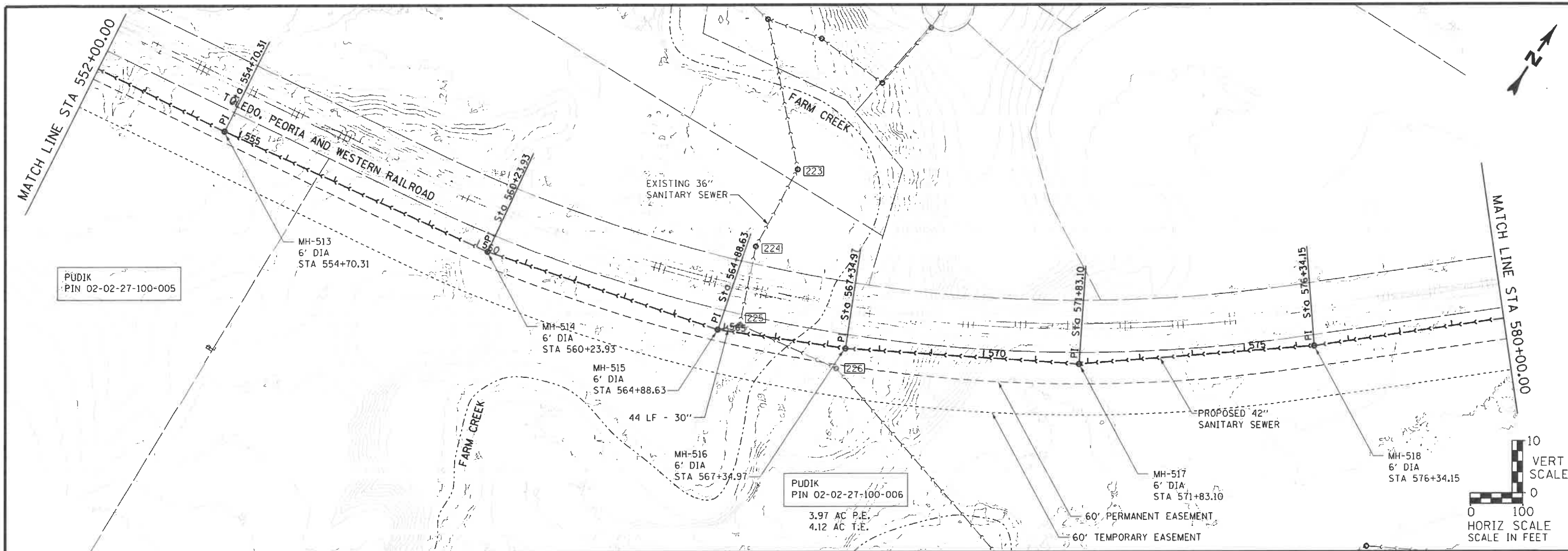

NO.	REVISIONS	DATE:

ALTERNATE B PLAN AND PROFILE
FARM CREEK TRUNK SEWER REPLACEMENT PROJECT
 CITY OF WASHINGTON
 TAZEWELL COUNTY, ILLINOIS

JOB NO.
1879.026
 PROJECT MGR.
AJS



SHEET
B-3

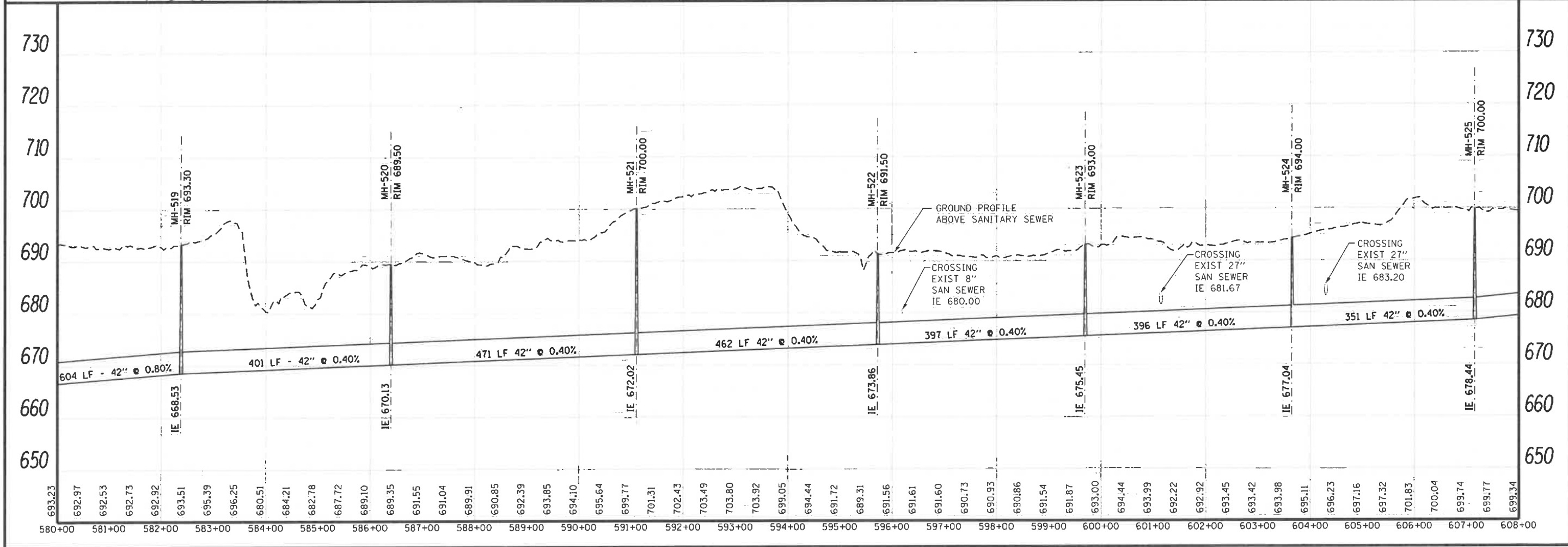
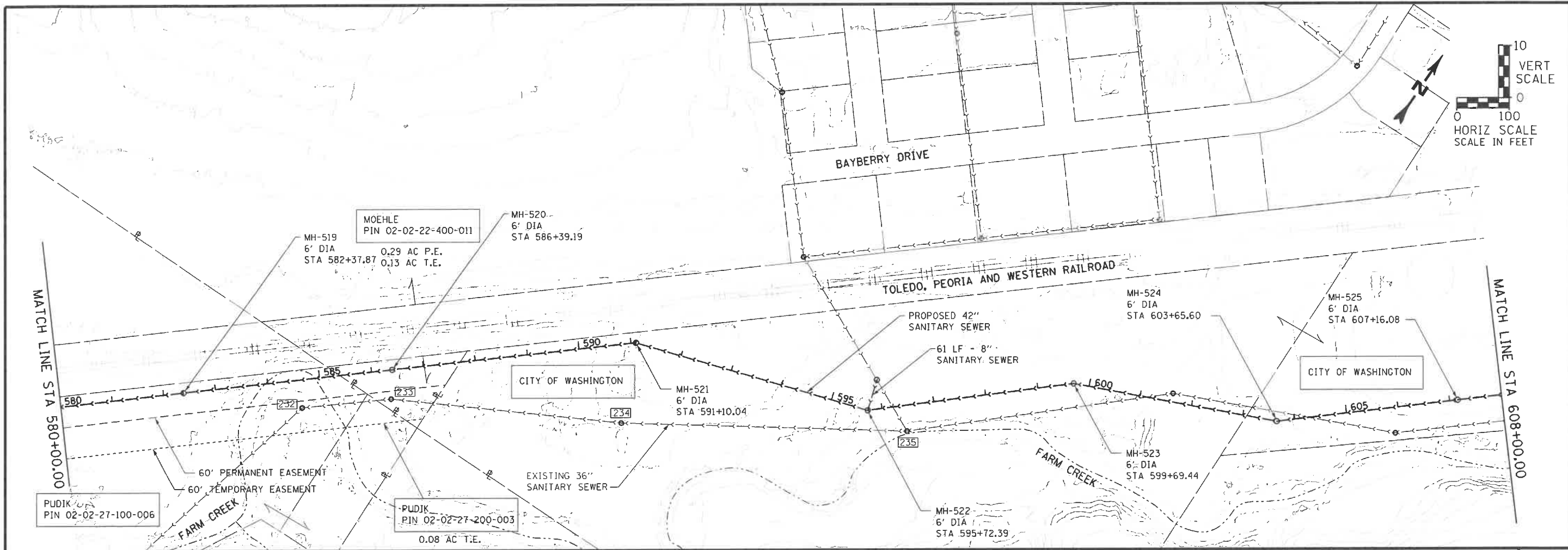

NO.	REVISIONS	DATE

ALTERNATE B PLAN AND PROFILE
FARM CREEK TRUNK SEWER REPLACEMENT PROJECT
 CITY OF WASHINGTON
 TAZEWELL COUNTY, ILLINOIS

JOB NO.
1879.026
 PROJECT MGR.
AJS



SHEET
B-4

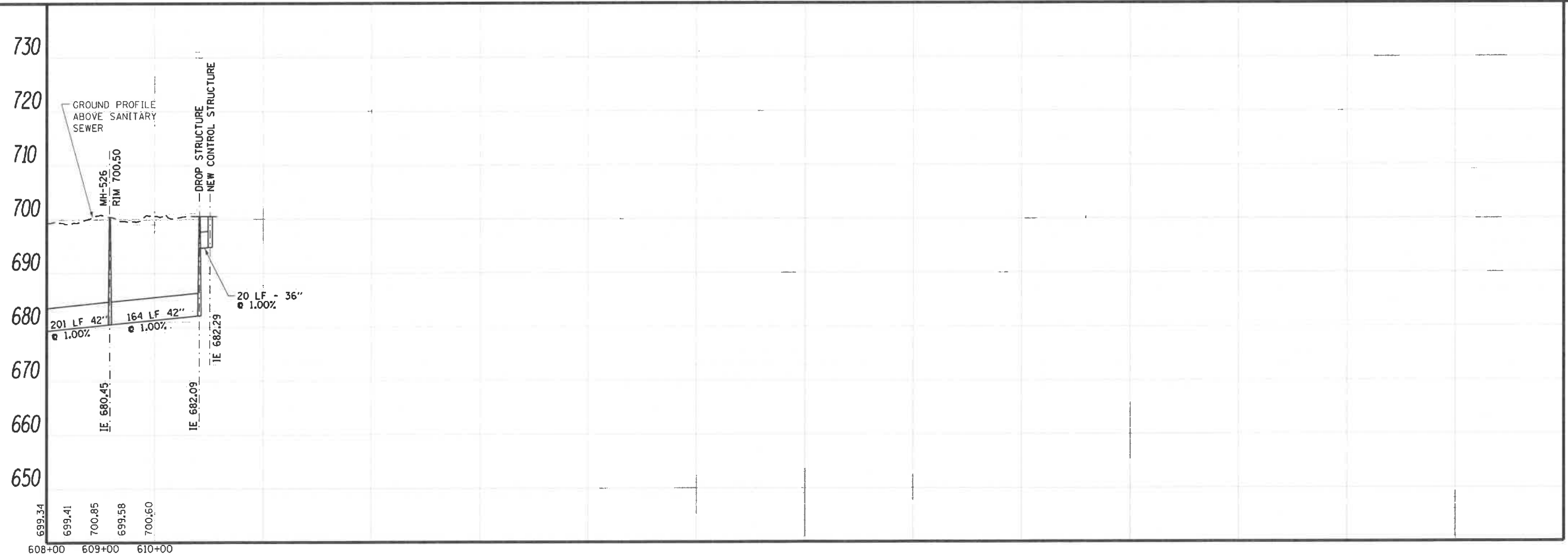
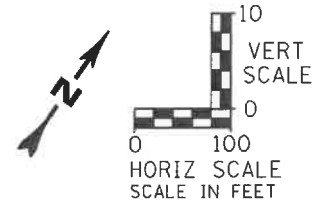
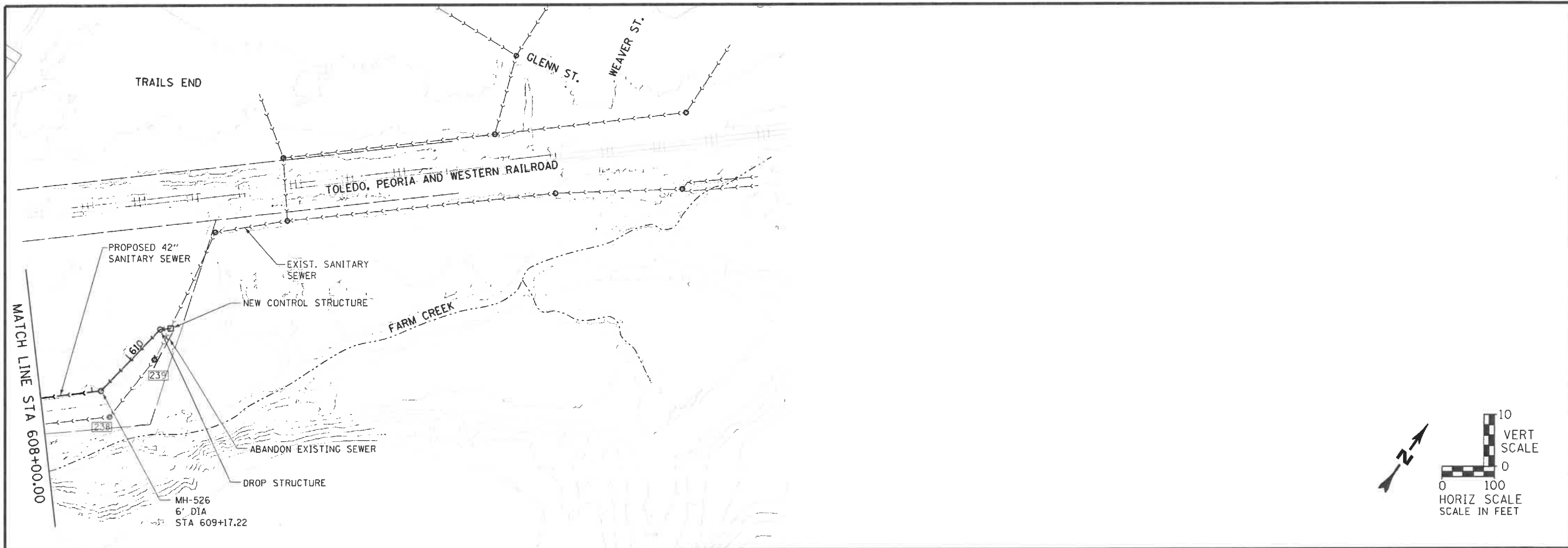

NO.	REVISIONS	DATE:

ALTERNATE B PLAN AND PROFILE
 FARM CREEK TRUNK SEWER REPLACEMENT PROJECT
 CITY OF WASHINGTON
 TAZEWELL COUNTY, ILLINOIS

JOB NO.
1879.026
 PROJECT MGR.
AJS



SHEET
B-5

Current Dry Weather Flow Conditions
Route A 36-Inch Pipe

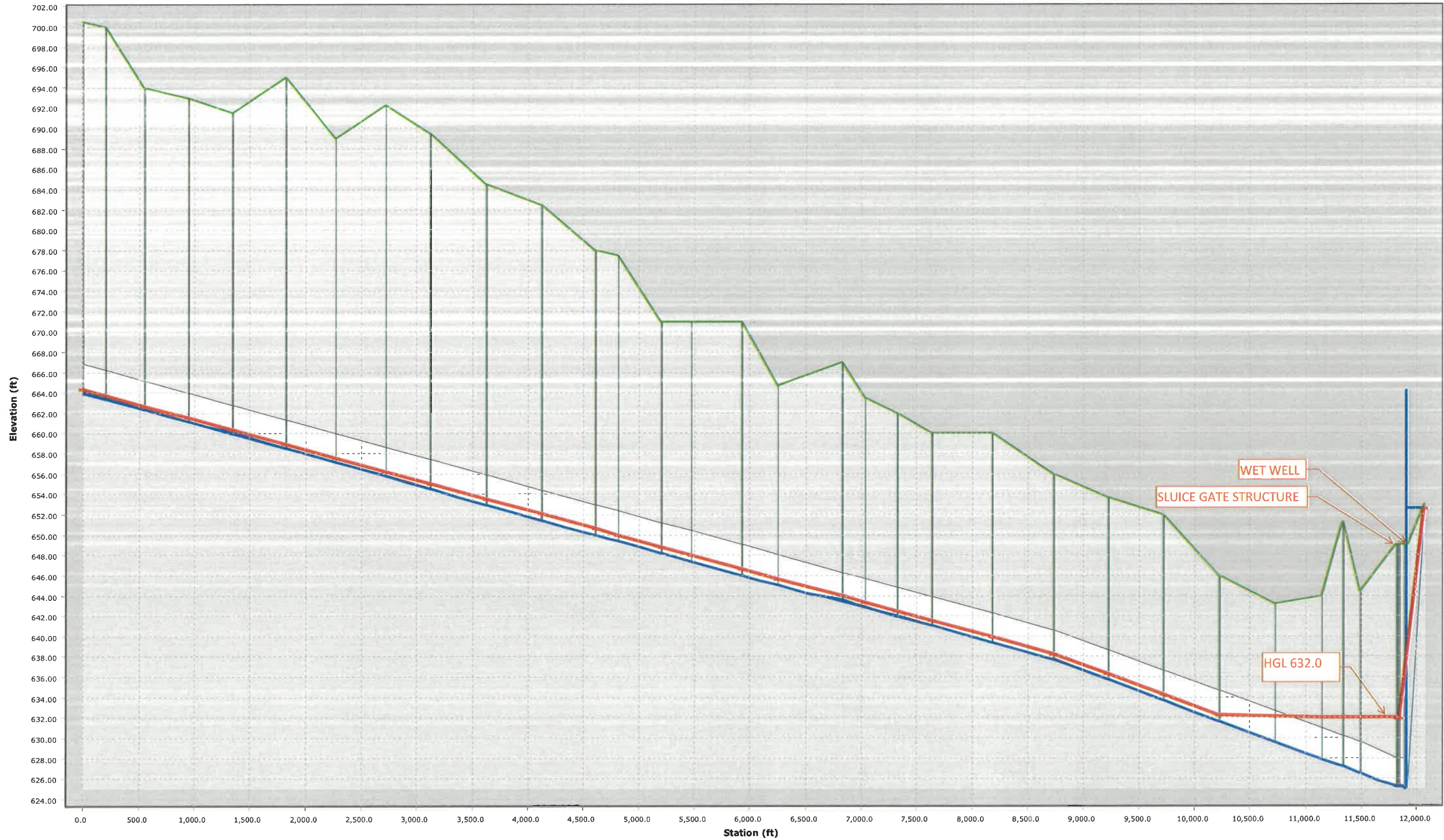

EGL
HGL
MaxHGL

WET WELL
SLUICE GATE STRUCTURE
HGL 632.0

FIGURE C.1.a

Current Design Peak Flow Conditions (July 6 Event)
Route A 36-Inch Pipe

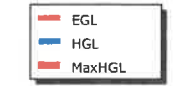
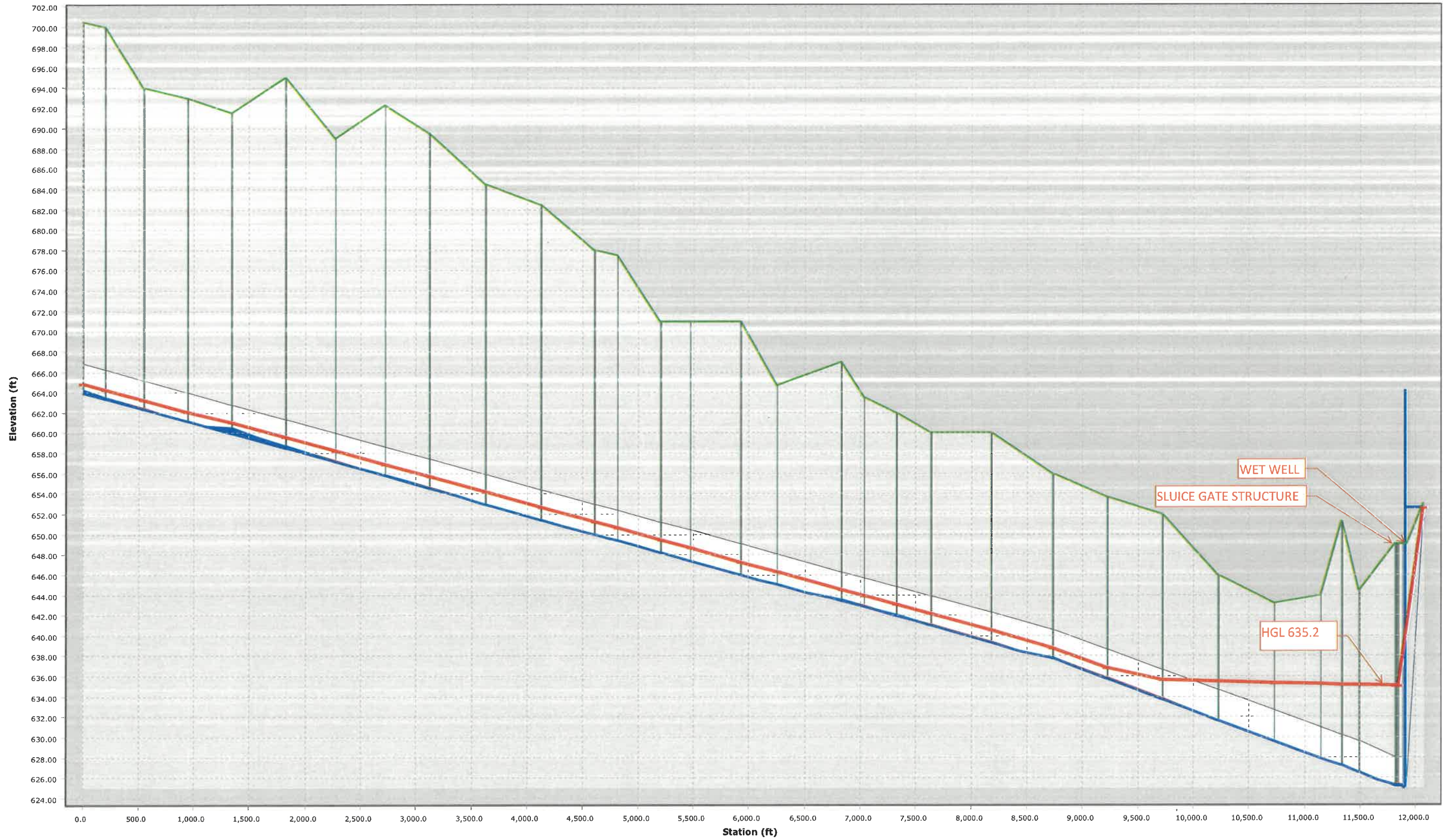
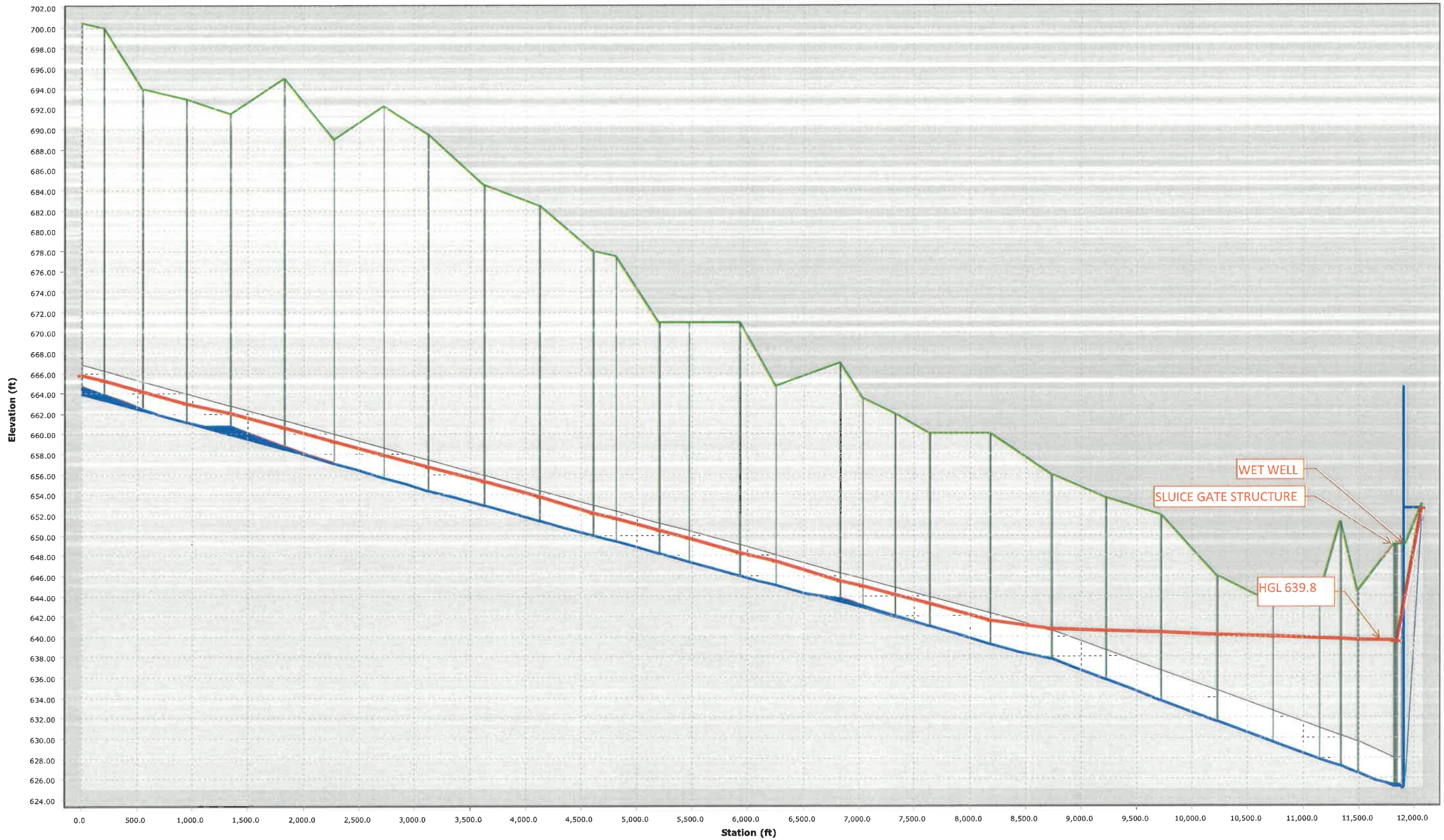

FIGURE C.1.b

Current Design Max Flow Conditions (August 30 Event)
Route A 36-Inch Pipe



EGL
HGL
MaxHGL

FIGURE C.1.c

Future Dry Weather Flow Conditions
Route A 36-Inch Pipe

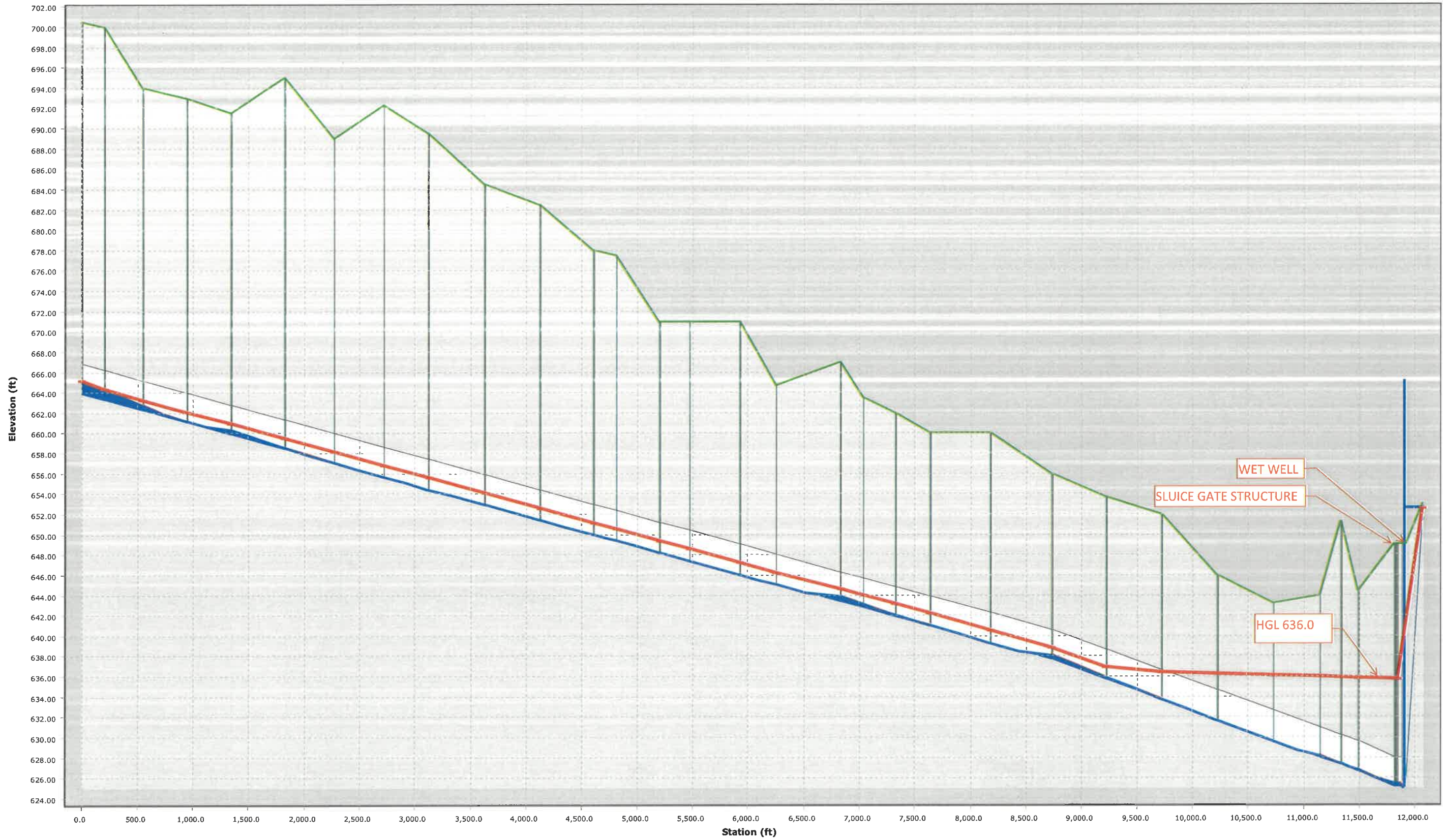

FIGURE C.2.a

Future Dry Weather Flow Conditions without Sluice Gate and Pumping Station
Route A 36-Inch Pipe

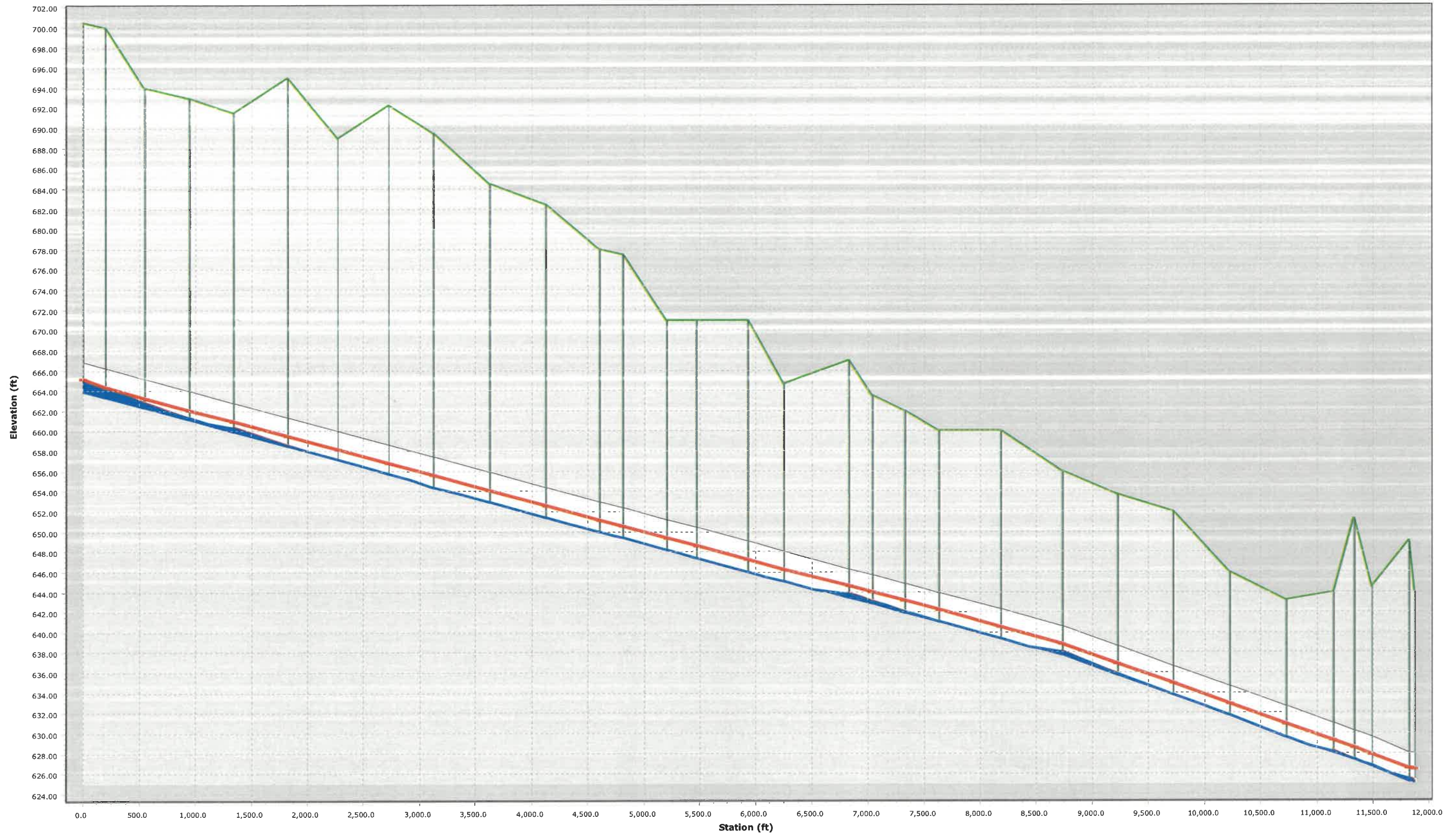
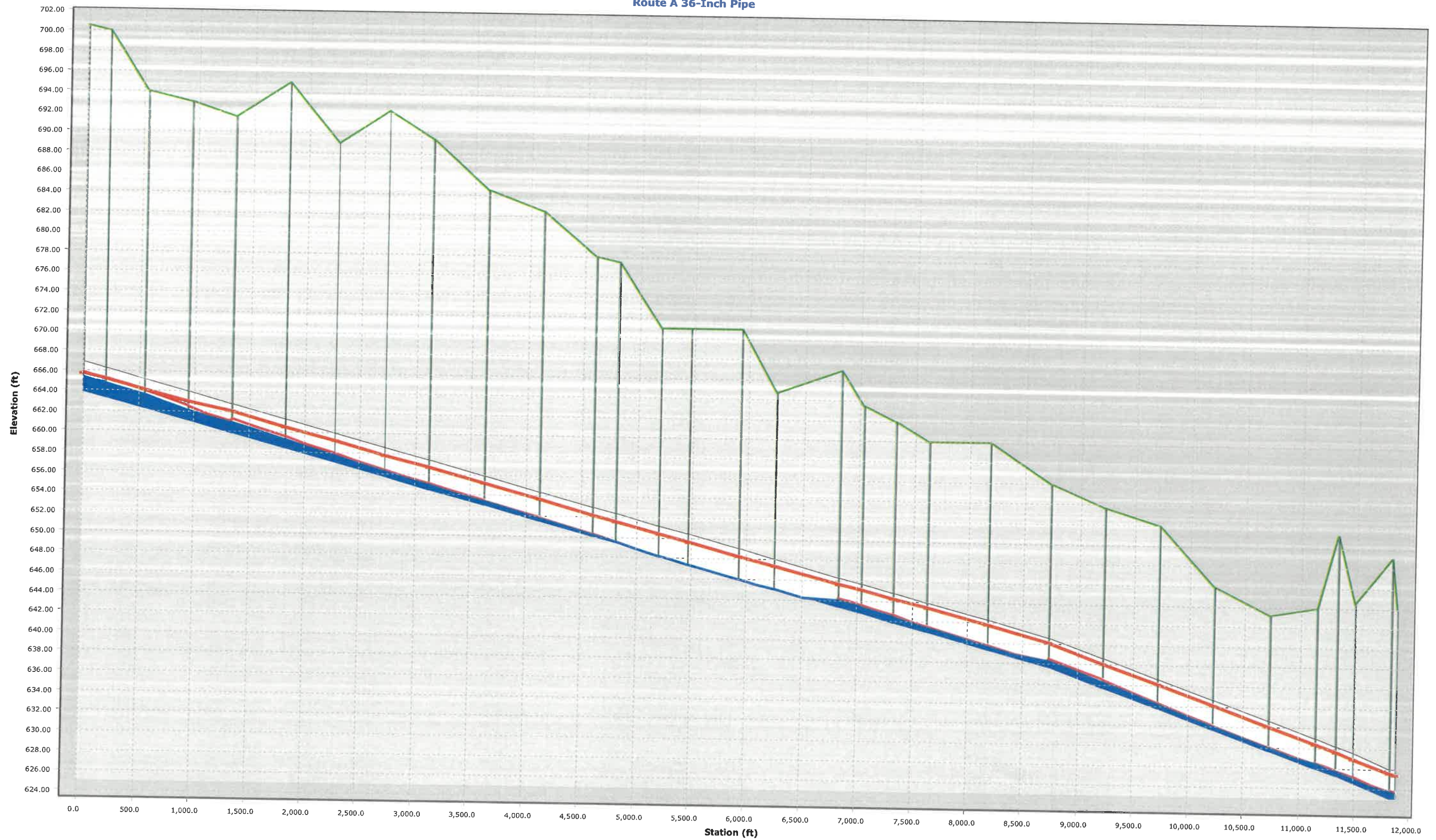

FIGURE C.3.a

Future Design Peak Flow Conditions (July 6 Event) without Sluice Gate and Pumping Station
Route A 36-Inch Pipe



EGL
HGL
MaxHGL

FIGURE C.3.b

Future Design Max Flow Conditions (August 30 Event) without Sluice Gate and Pumping Station
Route A 36-Inch Pipe

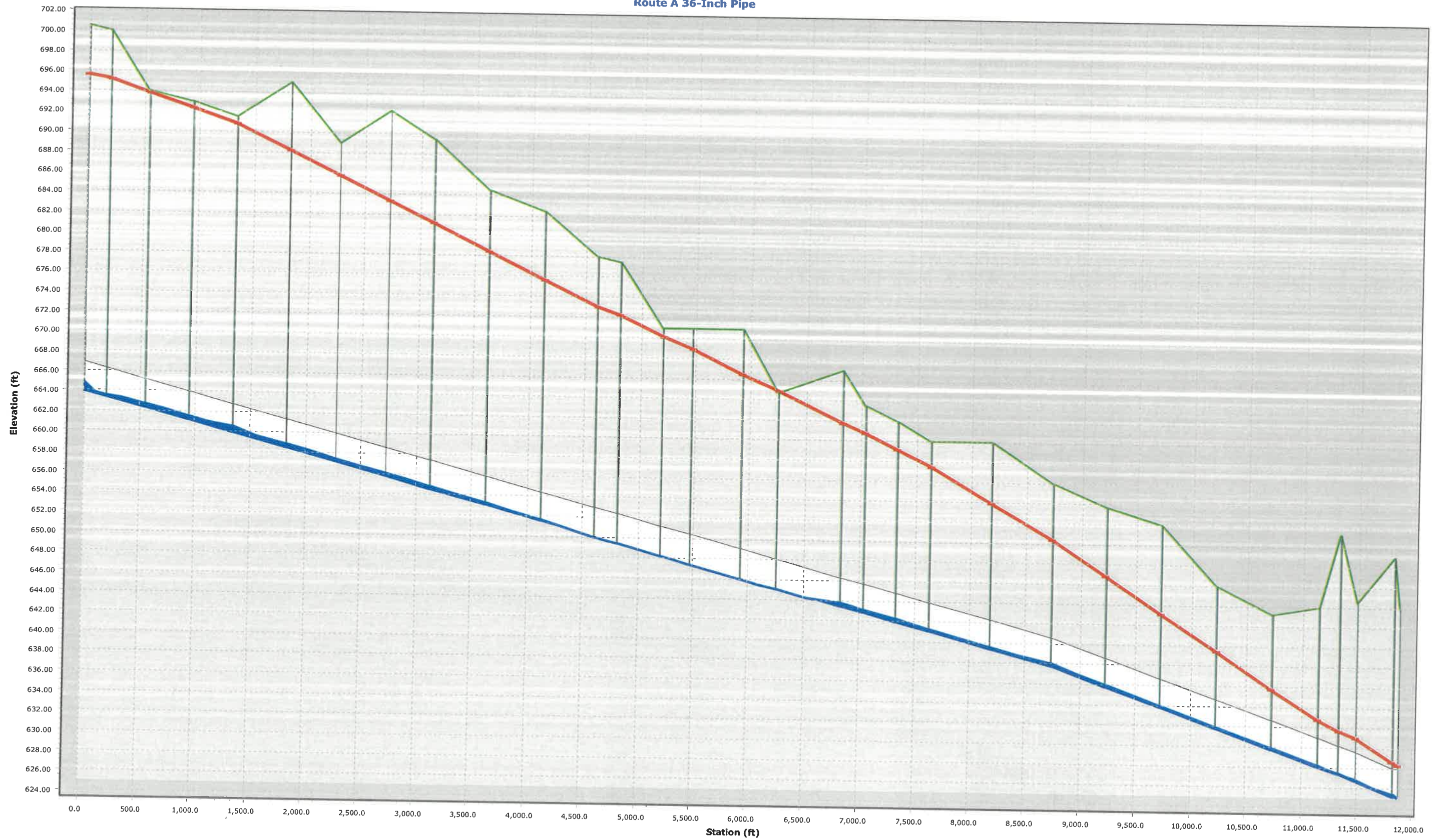

EGL
HGL
MaxHGL

FIGURE C.3.c

Future Dry Weather Flow Conditions without Sluice Gate and Pumping Station
Route B 36-Inch Pipe

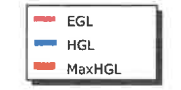

FIGURE C.3.d

Future Design Peak Flow Conditions (July 6 Event) without Sluice Gate and Pumping Station
Route B 36-Inch Pipe



EGL
HGL
MaxHGL

FIGURE C.3.e

Future Design Max Flow Conditions (August 30 Event) without Sluice Gate and Pumping Station
Route B 36-Inch Pipe

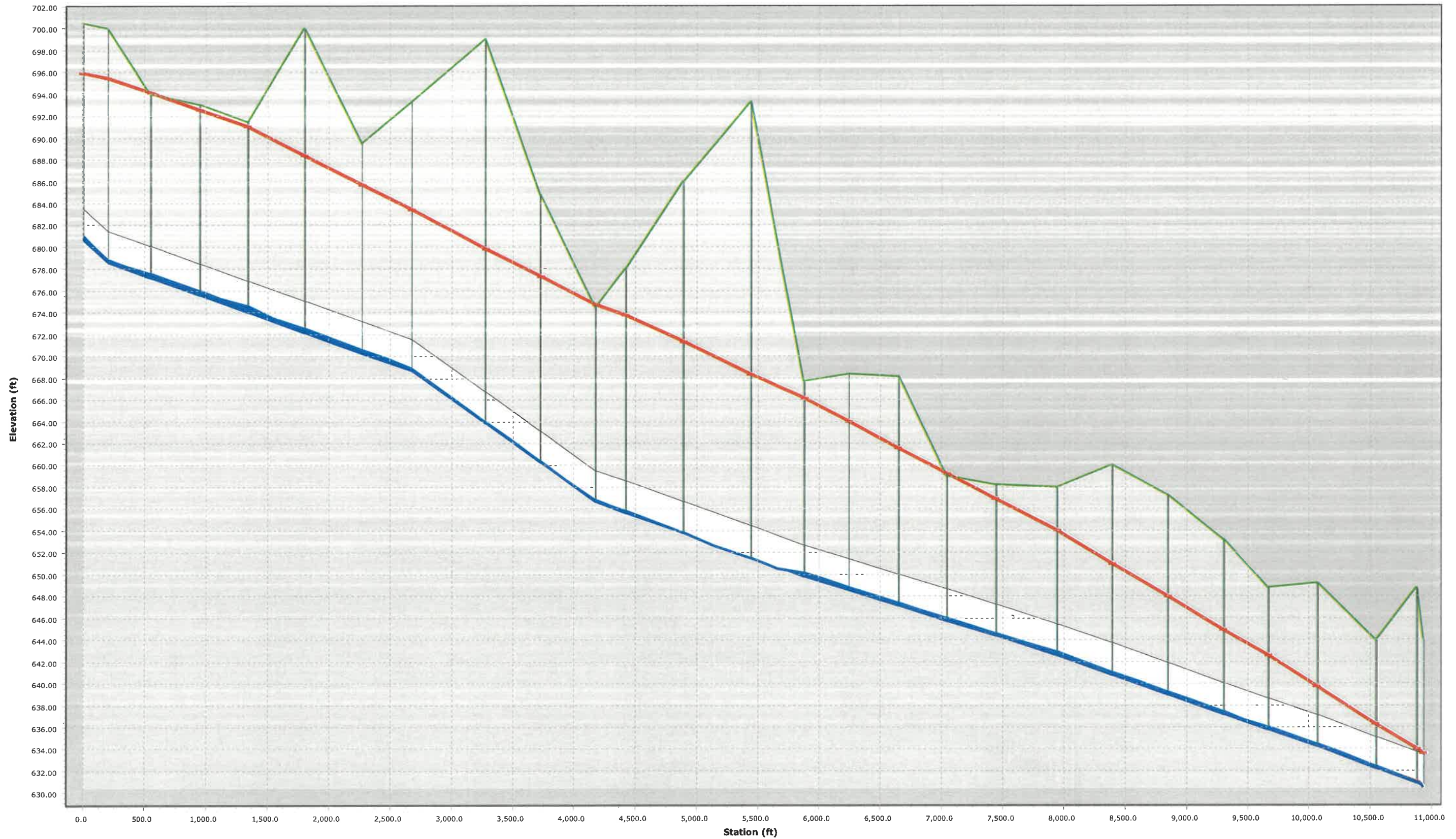

EGL
HGL
MaxHGL

FIGURE C.3.f

**Future Design Max Flow Conditions (August 30 Event) without Sluice Gate and Pumping Station
Route A 42-Inch Pipe**

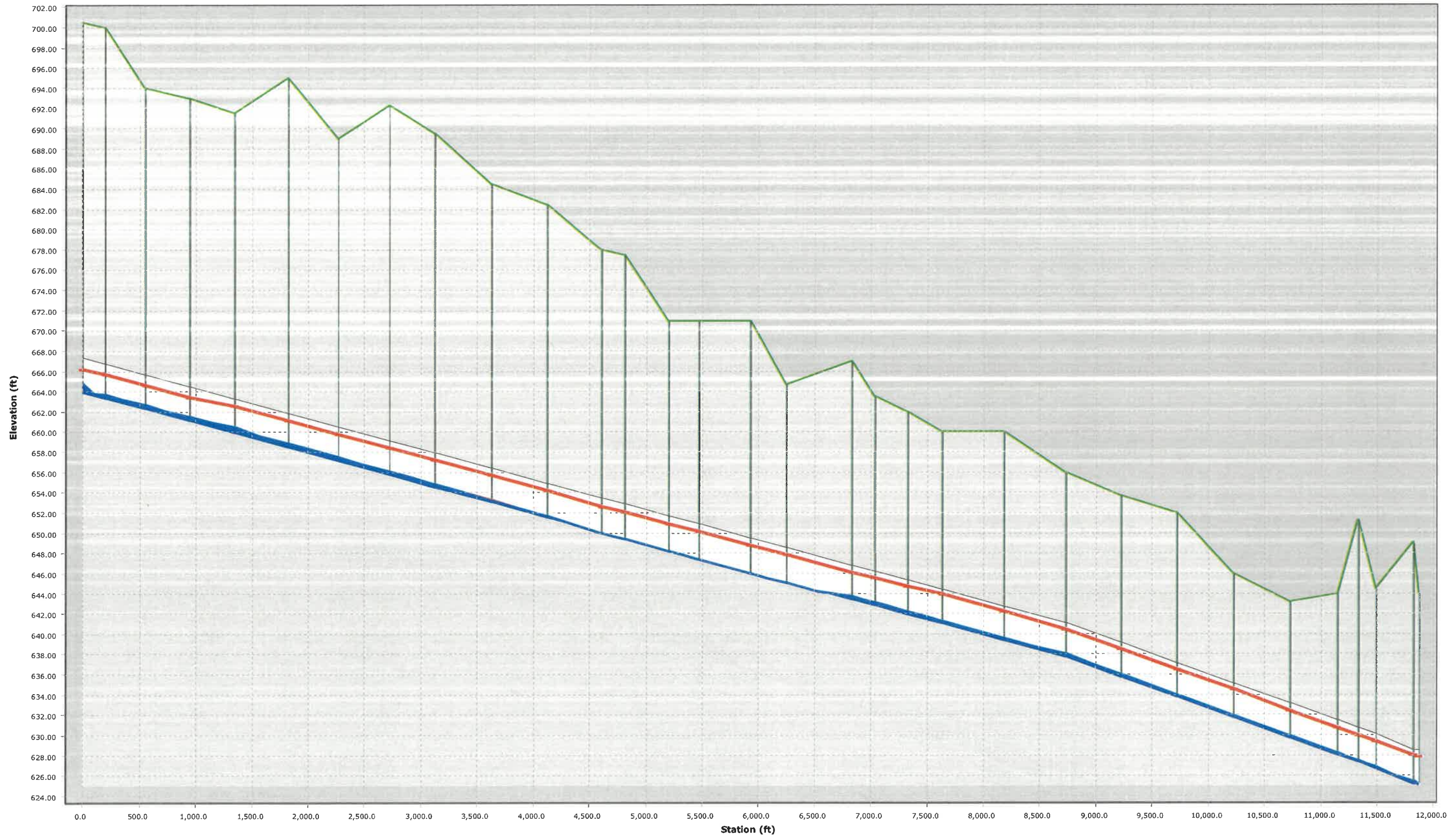

FIGURE C.3.g

Future Design Max Flow Conditions (August 30 Event) without Sluice Gate and Pumping Station
Route B 42-Inch Pipe



FIGURE C.3.h

For more location information
please visit www.strand.com

Office Locations

Brenham, Texas | 979.836.7937

Cincinnati, Ohio | 513.861.5600

Columbus, Indiana | 812.372.9911

Columbus, Ohio | 614.835.0460

Indianapolis, Indiana | 317.423.0935

Joliet, Illinois | 815.744.4200

Lexington, Kentucky | 859.225.8500

Louisville, Kentucky | 502.583.7020

Madison, Wisconsin* | 608.251.4843

Milwaukee, Wisconsin | 414.271.0771

Phoenix, Arizona | 602.437.3733

*Corporate Headquarters

